

Product Catalog



Effective November, 2014

B | BRAUN
SHARING EXPERTISE

Section A	Admixture Products
Needleless Dispensing Pins	A1-A3
Multidose Vial Adapter	A4
Vented Needles and Dispensing Connectors	A4
Syringe Caps	A4-A5
Additive Cap	A5
Chemo Dispensing Pins	A6
ONGUARD™ Contained Medication System with Tevadaptor® Components	A7
Admixture Accessories	A8-A9
MULTI-AD® Fluid Dispensing System	A10
Filtered Medication Transfer Devices	A11
Fluid Transfer Sets	A12-A13
Pre-Filled Flush Syringes	A14
PINNACLE® TPN Management System and Accessories	A15
Mixing Containers	A16-17
QC TESTER™ Whole Solution Contamination Tester	A18

Section B	Needles and Syringes
Hypodermic Needles	B1
Tuberculin Syringes	B2
Insulin Syringes	B2
Syringes/Syringes with Needles 1 mL to 5 mL	B3
Syringes/Syringes with Needles 10 mL to 100 mL	B4
Injekt™ two-piece Syringes (Value Line)	B5

Section C	IV Fluids & Irrigation, Wound Care, CAPS®, Electrolyte Charts
DUPLEX® Drug Delivery System	C1
Pre-mixed Pharmaceuticals	C2-C3
Empty Containers, Accessories	C4
IV Nutrition Products	C5-C6
General Purpose IV Solutions	C7-C10
Special Purpose IV Solutions	C10
Container Accessories	C10
Irrigation/Urology Solutions	C11
Irrigation/Urology Sets and Accessories	C12-C13
Prontosan® Wound Irrigation Solution and Wound Gel	C14
CAPS Pharmacy Admixture Services	C15
Electrolytic Charts	C16-C18

Section D	Infusion Systems
Outlook® ES Safety Infusion System	D1-D2
DoseTrac® Infusion software	D2
Outlook Pump Sets	D3-D9
Perfusor® Space and Infusomat® Space Pumps	D10
Space Pump Accessories	D10
Infusomat Space Pump Sets	D11-D14
Vista® basic Infusion Pump	D15
Vista basic Pump Sets	D15-D17
BodyGuard® Infusion Pumps	D18-D19
BodyGuard Infusion Pump Accessories	D20-D22
BodyComm® Pump Communication System	D22
BodyGuard Lock Boxes	D22
BodyGuard Administration Sets	D23-D26
Syringe Pump Sets	D27
IV Poles and Stands	D28

Section E	Anesthesia IV, IV Administration, and Needleless Products and Sets
Anesthesia IV Products and Sets	
Stopcocks and Manifolds	E1-E2
ULTRAPORT™ Luer-Activated Stopcocks	E3
Anesthesia Manifolds	E4
Anesthesia Accessories	E5
ULTRAPORT Anesthesia Stopcock Extension Sets	E6
Anesthesia Manifold Extension Sets	E6
Anesthesia Stopcock Extension Sets	E7
ULTRAPORT Needleless Stopcock Extension Sets	E8
Manifold Delivery Sets	E9
IV Administration Sets	
Basic IV Administration and Extension Sets	E10-E15
Syringe Pump Extension Sets	E16
Filtered Extension Sets	E17-E18
Blood Administration Sets and Accessories	E19-E20
RATE FLOW® Regulator Administration Sets	E21
Special Application Accessories	E22
Injection and Replacement Caps	E23
Needleless Products and Sets	
CARESITE® (LAD) System	E24-E28
ULTRASITE® Needleless System	E29-E37
SAFELINE® Needleless System	E38-E42
CYTOGUARD™ Closed Luer Connector	E42

Section F Pain Control

PERIFIX® Epidural Needles, Catheters	F1
Epidural Accessories and Sets	F2
PERIFIX Single Dose Epidural Trays	F3
PERIFIX Continuous Epidural Trays	F4-F5
Pediatric Epidural Trays and ESPOCAN® CSE Sets	F6
ESPOCAN/non-ESPOCAN Combined Spinal/Epidural Trays	F7
Spinal Needles and Accessories	F8
PENCAN® and SPROTTE® Spinal Trays	F9
SPINOCAN® Spinal Trays/Spinal Support Trays	F10
STIMUPLEX® Nerve Stimulator Products	F11
Continuous Nerve Block Sets	F12
Continuous Nerve Block Sets and Support Trays	F13
CONTIPLEX® and PLEXUFIX® Nerve Block Trays	F14

Section G Renal Therapies /Dialysis

Dialog™ Evolution Hemodialysis System and Accessories	G1-G2
Reverse Osmosis Water Treatment Systems and Supplies	G3
Dialyzer Re-Use Products	G4
Fistula Needles, AVF Needle Sets	G4-G5
Streamline® Bloodlines, Dialyzers	G6
Ancillary Disposable Products, Needleless Products , Misc.	G7-G8
Syringes and Needles for Dialysis	G9
DIAPACT® CRRT System	G10
Duosol™ Solutions for CRRT	G11
H.E.L.P.™ LDL-Apheresis Therapy	G12

Section H Vascular Access

Introcan Safety® IV Catheters	H1
WHIN® SAFE Safety Huber Needles	H2
WHIN® Winged Huber Infusion Needles	H3-H4
Dressing Change Kits	H5
IV Start Kits, Custom Kit Program	H6

Index, Terms & Conditions, Trademarks

B. Braun Phone Numbers

Clinical and Technical Support	800-854-6851
Infusion Systems Customer Support, including Infusion Pumps, IV Poles, PINNACLE® TPN Management System, and Pump Repairs only	800-627-7867
Customer Support for all other products, including disposables for infusion pumps and PINNACLE® TPN Management System	800-227-2862
Customer Support for Canada	800-624-2920

ADMIXTURE PRODUCTS

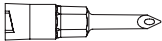
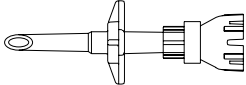
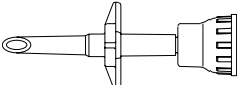
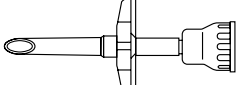
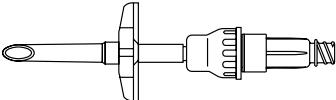
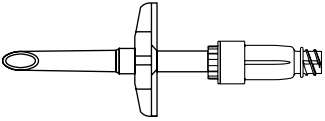
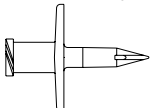
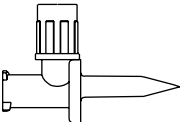
Description	Product Code	REF Number	Units Per cs
Needleless Dispensing Pins			
<i>All components on this page do not contain DEHP or natural rubber latex.</i>			
	MP1000	415019	100
<p>MICRO PIN® non-vented, single use dispensing pin for withdrawal or injection of medication from rubber-stoppered vials. Luer lock connector.</p>			
	DP3500	413500	50
<p>Non-vented Dispensing Pin with SAFSITE® Valve. Automatic Two-Way Valve for aspiration or injection of medication from inverted bags or semi-rigid plastic containers. Luer slip connector.</p>			
	DP3500L	413501	50
<p>Non-vented Dispensing Pin with SAFSITE Valve – same features as 413500 except with a luer lock connector.</p>			
	DPO3500L	412022	50
<p>Non-vented Dispensing Pin with One-Way Valve – for aspiration of medication from inverted bags or semi-rigid plastic containers. Luer lock connector.</p>			
	DPO4000L	412023	50
<p>Non-vented dispensing pin with One-Way Valve and ULTRASITE® valve. For aspiration of medication from inverted bags or semi-rigid plastic containers.</p>			
	US10	412027	50
<p>Non-vented dispensing pin with ULTRASITE valve. Two-way valve for aspiration or injection.</p>			
	DP4000	413503	100
<p>Non-vented MINI-SPIKE® Dispensing Pin – for withdrawal or injection of medication from multi-dose rubber-stoppered vials. Luer lock connector.</p>			
	DP1000	412012	50
<p>MINI-SPIKE IV Additive Dispensing Pin – for preparing and dispensing diluent or additive from multi-dose rubber-stoppered vials. Utilizes a bacterial retentive air-venting filter. Proximal luer lock connector.</p>			

Description

Product Code REF Number Units Per cs

Needleless Dispensing Pins

All components on this page do not contain DEHP or natural rubber latex.

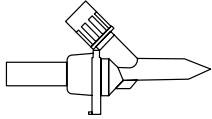

Standard Spike Dispensing Pin – for preparing and dispensing diluent or additive from multi-dose rubber-stoppered vials. Utilizes a bacterial retentive air-venting filter. Luer slip connector.

DP2000 412013 50

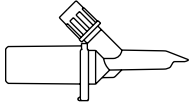

Standard Spike Dispensing Pin – with "D" hole design. For preparing and dispensing diluent or additive from multi-dose rubber-stoppered vials. Luer slip connector. Utilizes a bacterial retentive air-venting filter.

DP2001 412002 50

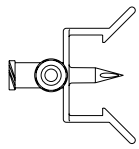

MINI-SPIKE® Dispensing Pin with Security Clip. For attachment to standard 20 mm rubber-stoppered vials. Used for preparing and dispensing diluent or additive from multi-dose vials. Utilizes a bacterial retentive air venting filter. Proximal luer lock connector.

DP1000SC 412004 50

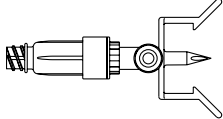

MINI-SPIKE Dispensing Pin with ULTRASITE® valve and security clip, for attachment to standard 20 mm rubber-stoppered vials, Two-Way Valve for aspiration and injection. Utilizes a bacterial retentive air-venting filter.

DP1800SC 413504 50

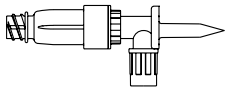

MINI-SPIKE Dispensing Pin with ULTRASITE valve for rubber-stoppered vials, Two-Way Valve for aspiration and injection. Utilizes a bacterial retentive air-venting filter.

US50 412026 50

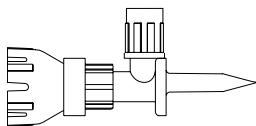



MINI-SPIKE Dispensing Pin with SAFSITE® Valve – automatic Two-Way Valve for aspiration or injection of medication from inverted multi-dose vials. Utilizes a bacterial retentive air-venting filter. Luer slip connector.

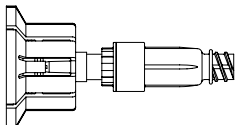



DP1500 412000 50

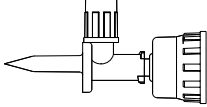
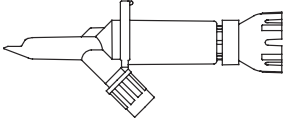
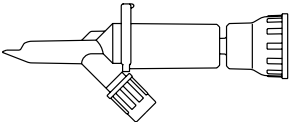
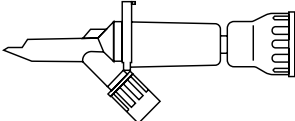
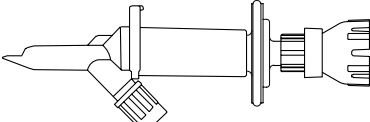

Non-Vented Vial Access Spike with ULTRASITE Valve and security clips Two-Way Valve for aspiration and injection of diluent or additive from 17mm and 20mm rubber-stoppered vials.

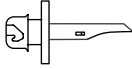
US1720SC 412720 50

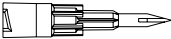
Description	Product Code	REF Number	Units Per cs
Needleless Dispensing Pins			
	DPO1500L	412020	50
<p>MINI-SPIKE® Dispensing Pin with One-Way Valve – for aspiration of medication from inverted multi-dose vials. Luer lock connector. Utilizes a bacterial retentive air-venting filter. Components do not contain DEHP or natural rubber latex.</p>			
	DP2500	412005	50
<p>Standard Spike Dispensing Pin with SAFSITE® Valve – automatic Two-Way Valve for aspiration or injection of medication from inverted multi-dose vials. Luer slip connector. Utilizes a bacterial retentive air-venting filter. Components do not contain DEHP or natural rubber latex.</p>			
	DP2500L	412006	50
<p>Standard Spike Dispensing Pin with SAFSITE Valve – same features as 412005 except with a luer lock connector. Components do not contain DEHP or natural rubber latex.</p>			
	DPO2500L	412021	50
<p>Standard Spike Dispensing Pin with One-Way Valve – for aspiration of medication from inverted multi-dose vials. Luer lock connector. Utilizes a bacterial retentive air-venting filter. Components do not contain DEHP or natural rubber latex.</p>			
	DP2505	412008	50
<p>Standard Spike Dispensing Pin with SAFSITE Valve and Filter – 5µ disk filter with automatic Two-Way Valve for filtered syringe aspiration or injection from suspended multi-dose vials. Luer slip connector. Utilizes a bacterial retentive air-venting filter. Components do not contain DEHP or natural rubber latex.</p>			
	DPL2500	412007	50
<p>Standard Spike Dispensing Pin with 24 in. Extension Line and SAFSITE Valve – for aspiration of medication from inverted multi-dose vials. Luer slip connector. Utilizes a bacterial retentive air-venting filter. Components do not contain natural rubber latex.</p>			

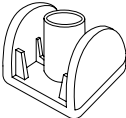
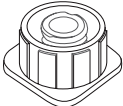
Description	Product Code	REF Number	Units Per cs
Multidose Vial Adapter			
<i>All components on this page do not contain DEHP or natural rubber latex.</i>			
	NF9280	NF9280	100
SAFELINE® multidose vial adapter – split septum for multiple access with blunt cannula.			
Vented Needles and Dispensing Connectors			
	VN1000	415070	100
Vented Needle – vented piercing pin for drug reconstitution. Luer lock connector.			
	VN1000L	415072	100
Lateral Flow Vented Needle – vented piercing pin, specifically designed to minimize drug foaming during the reconstitution process. Luer lock connector.			
	FDC1000	415080	100
Fluid Dispensing Connector – proximal and distal female luer lock connector. Used for pre-filling unit dose syringes from a large master syringe (color – green).			
	FDC2000	415081	100
Fluid Dispensing Connector – proximal female luer lock and distal female luer slip connector. Used for transferring medication from syringe to syringe or between a syringe and a master container with a male luer connector (color – blue).			
Syringe Caps			
	SC1000	418010	500
MULTI-AD® Syringe Cap – used for capping luer tip syringes. Unique 10 per blister package protects sterility of unopened caps and aids in capping. 50 packs per case (color – green).			
	SC2000	418012	500
MULTI-AD Luer Lock Syringe Cap – used for capping luer slip or luer lock syringes. Unique 10 per blister package protects sterility of unopened caps and aids in capping. 50 packs per case (color – red).			
MULTI-AD Luer Lock Syringe Cap – same as 418012 (color – blue).	SC3000	418013	500

ADMIXTURE PRODUCTS

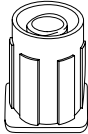
Description	Product Code	REF Number	Units Per cs
Syringe Caps			
<i>All components on this page do not contain DEHP or natural rubber latex.</i>			
	SCF130	418200	600
Flexible Syringe Cap – used for capping luer tip syringes. Unique 30 per blister package protects sterility of unopened caps and aids in capping. 20 packs per case (color – white).			
Flexible Syringe Cap – same as 418200 (color – blue).	SCF230	418202	600
Flexible Syringe Cap – same as 418200 (color – yellow).	SCF330	418203	600
	TEC1000	418004	500
Tamper-Evident Syringe Cap – used for capping luer lock syringes. This syringe cap is tamper-evident which provides improved quality control of prepared syringes. Unique 10 per blister package protects sterility of unopened caps and aids in capping. 50 packs per case (color – red).			
	N7820	N7820	500
ADD-PRO™ Syringe Caps – used for capping luer tip syringes. Unique 20 per blister package protects sterility of unopened caps and aids in capping. 25 packs per case (color – beige).			

Additive Cap

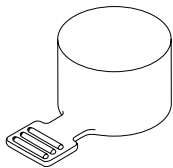

BIG TAB® Additive Cap – extra-large, ribbed finger grip with tamper-evident feature fits 28 mm bottle tops. Packed individually, sterile.(color - green). AC28 315000 100

Description

Product Code REF Number Units Per cs

Chemo Dispensing Pins

All components on this page do not contain DEHP or natural rubber latex.

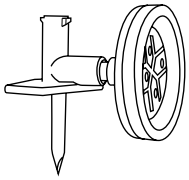

Chemo Dispensing Pin™ – with Distal MINI-SPIKE® connector, and built-in 0.2 micron hydrophobic air-venting filter. Designed to eliminate aerosoling of chemotherapeutic medications during the reconstitution and dispensing process. Proximal luer lock connector.

CDP2000 412014 50

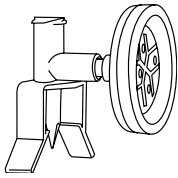

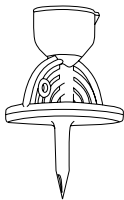

Chemo Dispensing Pin S.C. – with Security Clip for attachment to standard 20 mm rubber-stoppered vials. Built-in 0.2 micron hydrophobic air venting filter designed to eliminate aerosoling of chemotherapeutic medications during the reconstitution and dispensing process. Proximal luer lock connector.

CDP2000SC 412003 50

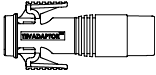
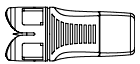
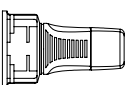
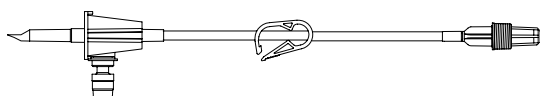
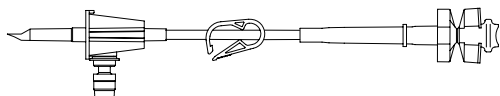

Chemo Dispensing Pin with MINI-SPIKE Plus connector. Designed to eliminate aerosoling of chemotherapeutic medications during the reconstitution and dispensing process. With 0.2 micron air filter, 5 micron fluid filter and integrated snap-lock cap protecting luer lock connector.

CDP3005 412011 100

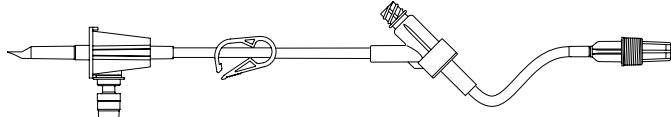
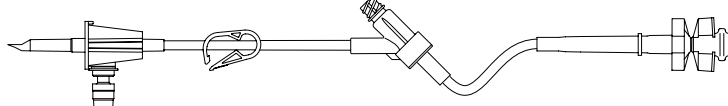
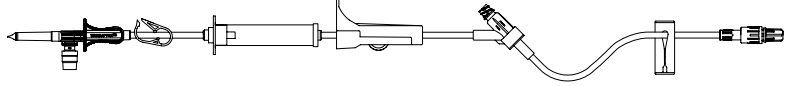
Description	Product Code	REF Number	Units Per cs
Closed System Drug-transfer Devices			
ONGUARD™ Contained Medication System with Tevadaptor® Components			
 <p>Tevadaptor Syringe Adaptor - for use with luer lock syringes. Enables closed fluid transfers using syringe and various Tevadaptor components through dedicated device connections. Components do not contain DEHP or natural rubber latex. 50/box, 6 boxes/case</p>	412118	412118	300
 <p>Tevadaptor Vial Adaptor - for closed reconstitution and withdrawal of medications with most 20 mm and 13mm vials (with vial converter ring provided). Components do not contain DEHP or natural rubber latex. 50/box, 4 boxes/case</p>	412111	412111	200
 <p>Tevadaptor Vial Adaptor for 28 mm vials Components do not contain DEHP or natural rubber latex. 20/box, 4 boxes/case</p>	412119	412119	80
 <p>Tevadaptor Connecting Set - secondary tubing set for closed drug preparation and administration of IV medications. Proximal non-vented bag spike, on/off clamp, and distal male luer lock connector. Components do not contain DEHP or natural rubber latex. Length: 19 in. (49 cm)</p>	412112	412112	100
 <p>Tevadaptor Spike Port Adaptor - adapts a dedicated IV pump tubing set or gravity tubing set Proximal non-vented bag spike, on/off clamp and distal spike adaptor access. Components do not contain DEHP or natural rubber latex. Length: 8 in. (20 cm)</p>	412113	412113	100
 <p>Tevadaptor Luer Lock Adaptor - converts a standard luer activated valve for access with the Tevadaptor Syringe Adaptor. Components do not contain DEHP or natural rubber latex. 100/box, 4 boxes/case</p>	412114	412114	400
 <p>Tevadaptor Connecting Set with ULTRASITE® Needleless Valve - secondary tubing set. For closed drug preparation and administration of IV medication. Proximal non-vented bag spike, on/off clamp, ULTRASITE Valve and distal luer lock connector. Components do not contain natural rubber latex. Length 19 in. (49 cm)</p>	412115	412115	100
 <p>Tevadaptor Spike Port Adaptor Set with ULTRASITE Needleless Valve - adapts a dedicated IV pump tubing set, or gravity tubing sets. Proximal non-vented spike, on/off clamp, ULTRASITE Valve and distal spike adaptor access. Components do not contain natural rubber latex.. Length: 13 in. (33 cm)</p>	412116	412116	100
 <p>Tevadaptor Connecting Set with Drip Chamber and ULTRASITE Needleless Valve - for closed drug preparation and administration of IV medication. Proximal non-vented spike, on/off clamp, drip chamber, roller clamp, ULTRASITE Valve, slide clamp, Male luer lock connector. Components do not contain natural rubber latex. Priming volume: 12 mL, Length: 43 in. (108 cm),</p>	412120	412120	70

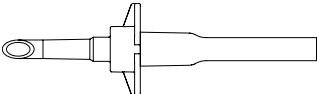
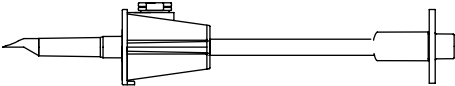
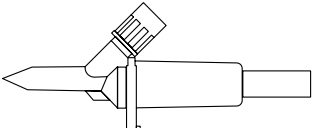
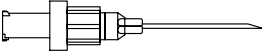
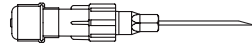
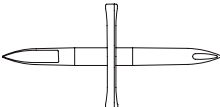
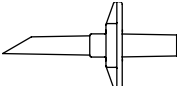
Description	Product Code	REF Number	Units Per cs
Admixture Accessories			
	N2050	N2050	24
<p>Non-Vented Spike Adapter – non-vented adapter permits connection of a vented IV spike to a semi-rigid plastic IV container. Components do not contain natural rubber latex.</p>			
	N2061	N2061	50
<p>Spike Adapter – Allows non-vented sets to be used with non-vented rigid IV solution containers. Components do not contain DEHP or natural rubber latex. Length: 4.5 in. (11 cm)</p>			
	SA2000	418105	50
<p>Vented Spike Adapter – to permit connection of non-vented IV spike to IV bottle requiring a vent. Components do not contain natural rubber latex.</p>			
	BC0017	415060	100
<p>Backcheck Valve with 17 Ga. x 1 in. Needle – for the injection of multiple additives to an IV bag injection port. Components do not contain DEHP or natural rubber latex. Priming Volume: 0.26 mL.</p>			
	IN2019	418019	100
<p>Intermittent Injection Port with 19 Ga. x 1 in. Needle – for the addition of multiple additives to the additive port of an IV bag. Components do not contain DEHP or natural rubber latex. Priming Volume: 0.24 mL.</p>			
	TR1000	415125	100
<p>Transofix™ Transfer Spike – double spike for rapid transfer of medication or diluent between rubber stoppered containers. Components do not contain DEHP or natural rubber latex.</p>			
	SA1000S	418102	50
<p>Blood Spike Adapter. Components do not contain DEHP or natural rubber latex.</p>			

ADMIXTURE PRODUCTS

Description	Product Code	REF Number	Units Per cs
Admixture Accessories			
<i>All components on this page do not contain DEHP or natural rubber latex.</i>			
Transfer Device Via Direct Vacuum			
			
Double-Ended Transfer Needle – proximal, 17 Ga. x 1 in. needle opposite 17 Ga. x 1/2 in. needle. Used for fast transfer of medication from rubber-stoppered vial to vacuumized IV container.	DN1017	415017	100

addEASE® Binary Connectors

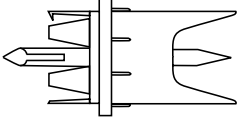
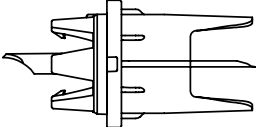
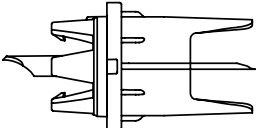
			
Binary Connector (20 mm) for use with PAB® Partial Additive Bag. Clear cap.	BC2000	BC2000	200
			
Binary Connector (13mm) for use with PAB® Partial Additive Bag. Blue cap.	BC1300	BC1300	200
			
Binary Connector for use with 250mL EXCEL® IV container. Steel bag spike, White cap.	N7995	N7995	200

PAB is a PVC-free, DEHP-free Partial Additive Bag
 EXCEL is a Latex-free, PVC-free, DEHP-free IV container

Description

Product Code REF Number Units Per cs

MULTI-AD® Fluid Dispensing System

All components on this page do not contain DEHP or natural rubber latex.

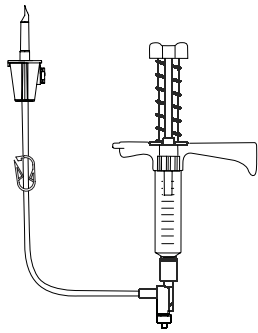

MULTI-AD Fluid Dispensing System – contoured grip on 10 cc luer lock syringe with adjustable automatic spring return, dual check valve, and universal spike on 41 in. (104.1 cm) transfer set.

MAC1001 513506 10

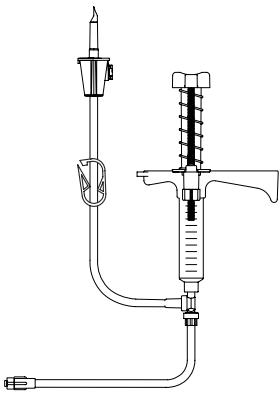

MULTI-AD Fluid Dispensing System – 10 cc luer lock syringe with adjustable automatic spring return, 41 inch (104.1 cm) vented transfer set, dual check valve, 40 in. extension set with distal luer lock connector. Use with MULTI-AD pump.

MA1040 513540 10

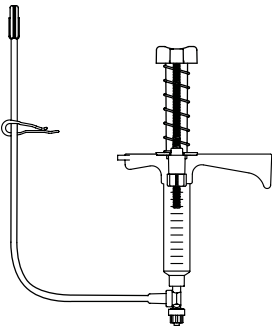

MULTI-AD Fluid Dispensing System – 10 cc luer lock syringe with adjustable automatic spring return, dual check valve, 30 in. (76.2 cm) transfer set with weighted sinker and tubing clip. For use with MULTI-AD pump or manual activation for use when dispensing fluids from an open container.



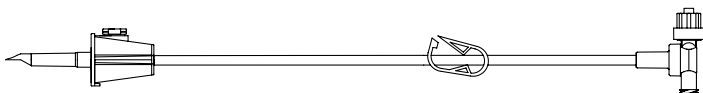



MA1000L 513501 10



MULTI-AD Transfer Set – vented transfer set with automatic two-way valve assembly, universal spike, on/off clamp, dual check valve. Accepts standard syringe for dispensing IV additives. Length: 43 in. (109.2 cm)

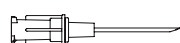

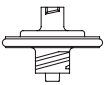
MAT4100 513548 20

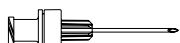
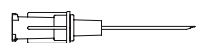
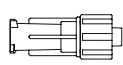
ADMIXTURE PRODUCTS

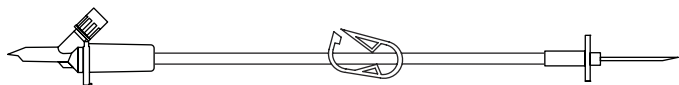
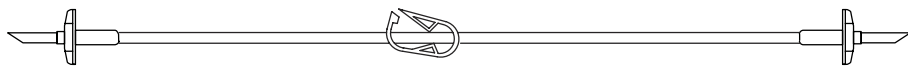
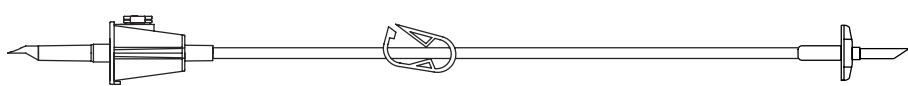
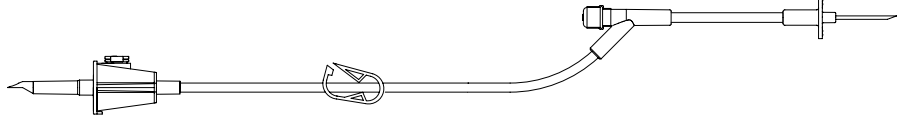
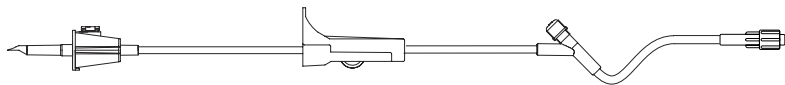
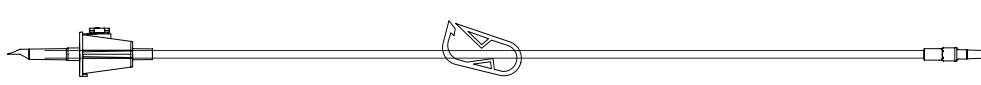
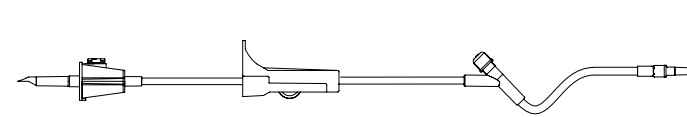
Description	Product Code	REF Number	Units Per cs
Filtered Medication Transfer Devices			
 FILTER STRAW® - 5 micron filter with 4 in. flexible straw for fluid aspiration from glass ampules. Components do not contain natural rubber latex.	FS5000	415020	100
 FILTER STRAW - 5 micron filter with 1¾ in. flexible straw for fluid aspiration from glass ampules. Components do not contain natural rubber latex.	FS5005	415021	100
 Filter-Needle - 5 micron filter in female luer lock connector with 20 Ga. x 1 ½ in. thinwall needle for withdrawal or injection of medication from rubber-stoppered vial. Components do not contain DEHP or natural rubber latex.	FN5120	415025	100
 Filter-Needle - 5 micron filter in female luer lock connector with 19 Ga. x 1 in. thinwall needle for withdrawal or injection of medication from rubber-stoppered vial. Components do not contain DEHP or natural rubber latex.	FN5019	415040	100
 Filter Needle II - removable 5 micron filter with attached 19 Ga. x 1 in. thinwall needle. Used for withdrawal or injection of medication from rubber-stoppered vial. Components do not contain DEHP or natural rubber latex.	FN5219	415042	100
 0.2 micron SUPOR® Aspiration/Injection Disc Filter – with proximal and distal luer lock connections designed for bacteria retentive filtration of medication. Components do not contain DEHP or natural rubber latex. Fluid retention is 0.3 mL (color: green)	PF2000	415002	50
1.2 micron SUPOR Aspiration/Injection Disc Filter with low drug binding membrane – proximal and distal luer lock connection designed for fungal and particulate filtration of medication. Components do not contain DEHP or natural rubber latex. Fluid retention is 0.3 mL. (color: clear)	PF1200	414995	50
5 micron SUPOR Aspiration/Injection Disc Filter with low drug binding membrane – proximal and distal luer lock connection designed for fungal and particulate filtration of medication. Components do not contain DEHP or natural rubber latex. Fluid retention is 0.3 mL. (color: purple)	PF5000	415008	50
 Filter Needle - 5 micron filter in female luer lock connector with 19 Ga. x 1 ½ in. thinwall needle for withdrawal or injection of medication from rubber-stoppered vial. Components do not contain DEHP or natural rubber latex.	FN5119	415030	100
 High Flow Filter Needle 19 Ga. x 7/8 in. needle with 5 micron filter, recommended for use with viscous medications. Components do not contain DEHP or natural rubber latex.	FN5019HF	415041	100
 Filter Needle - 5 micron filter in female luer lock connector with 20 Ga. x 1 in. thinwall needle for withdrawal or injection of medication from rubber-stoppered vial. Components do not contain DEHP or natural rubber latex.	FN5020	415035	100
 Filter Hub - 5 micron filter in male/female luer lock hub for use with standard luer connections. Components do not contain DEHP or natural rubber latex.	FH5000	418021	100

Description	Product Code	REF Number	Units Per cs
Fluid Transfer Sets without Filters			
 <p>Fluid Transfer Set – vented spike with gripping flange, large bore tubing with on/off clamp, and distal 17 Ga. x 1 in. needle with gripping flange. Used for direct transfer of fluids between large volume parenterals. Components do not contain natural rubber latex. Length: 24 in. (60.7 cm)</p>	FT1000	356050	50
 <p>Fluid Transfer Set – proximal and distal non-vented spikes, wide bore tubing with on/off clamp. Components do not contain DEHP or natural rubber latex. Length: 27 in. (68.6 cm)</p>	FT1002	356049	50
 <p>Fluid Transfer Set – universal spike, wide bore tubing with on/off clamp, distal non-vented spike. Components do not contain DEHP or natural rubber latex. Length: 27 in. (68.6 cm)</p>	FT1003	356043	50
 <p>Fluid Transfer Set – universal spike, large bore tubing with on/off clamp, Y-site for multiple injections, and distal 17 Ga. x 1 in. needle with gripping flange. Components do not contain DEHP or natural rubber latex. Length: 24 in. (60.7 cm)</p>	FT1100	356052	50
 <p>Fluid Transfer Set – universal proximal spike, roller clamp, injection site, and distal male luer lock connector. Components do not contain DEHP or natural rubber latex. Length: 30 in. (76.2 cm)</p>	FT1100L	356053	50
 <p>Fluid Transfer Set – universal proximal spike, wide bore tubing, on/off clamp, distal luer slip connector. Components do not contain DEHP or natural rubber latex. Length: 33 in. (79.1 cm)</p>	FT1000S	356048	50
 <p>Fluid Transfer Set – universal proximal spike, roller clamp, injection site, and distal luer slip connector. Components do not contain DEHP or natural rubber latex. Length: 22 in. (55.9 cm)</p>	FT1100S	356054	50

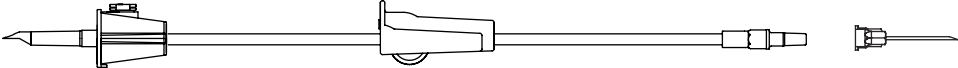
ADMIXTURE PRODUCTS

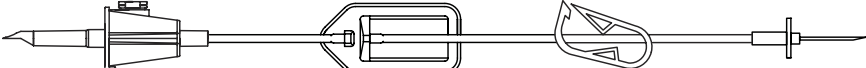
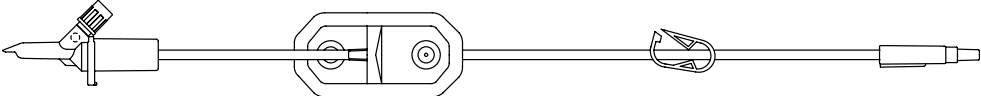
Description	Product Code	REF Number	Units Per cs
Fluid Transfer Sets without Filters			
	V1905	V1905	50
<p>Fluid Transfer Set – Universal spike, roller clamp, distal luer slip connector, 17 Ga. unattached needle. Length: 27 in. (68.6 cm)</p>			
	MCA108L	356074	50
<p>Fluid Transfer Set – Universal spike, on/off clamp, distal luer lock connector. Components do not contain DEHP or natural rubber latex. Length: 14 in. (35.6 cm)</p>			
Fluid Transfer Sets with Filters			
	FT5000	356055	50
<p>Fluid Transfer Set – Universal spike, large bore tubing, on/off clamp, 5µ SUPOR® filter and distal 17 Ga. x 1 in. needle with gripping flange. Used for direct filtered transfer of fluids between large volume parenterals. Components do not contain DEHP or natural rubber latex. Length: 25 in. (64 cm)</p>			
	FT2000S	358000	50
<p>Fluid Transfer Set – Vented spike with gripping flange, 0.2µ SUPOR filter, on/off clamp, and distal luer slip connector. Components do not contain natural rubber latex. Length: 35 in. (88.9 cm)</p>			

Supor is a registered trademark of Pall Corporation

ADMIXTURE PRODUCTS

Description		Product Code	REF Number	Units Per Cs
Pre-filled Flush Syringes				
Description	NDC#	Product Code	REF Number	Units per Cs
Sodium Chloride 0.9%				
2.5mL (in 3mL syringe)	63807010003	S3	513574	1000
5mL (in 10mL syringe)	63807010005	S5	513575	1000
10mL (in 10mL syringe)	63907010010	S10	513576	1200
Heparin 10 units per mL				
5mL (in 10mL syringe)	63807050005	X50	513602	1000
Heparin 100 units per mL				
5mL (in 10mL syringe)	63807060005	C50	513604	1000

Description	Product Code	REF Number	Units Per cs
PINNACLE® TPN Management System			



The PINNACLE TPN Management System streamlines your TPN process for improved safety and efficiency. The PINNACLE TPN Management System uses barcode verification and barcoded patient prescription to help reduce medication errors. Also, the Windows® browser-based TPN calculating software includes Trissel's™ Ca/P Check software and provides flexibility for single-, multiple-, and network-user access and internet capability.

PC 1000	PC1000	1
---------	--------	---

PINNACLE TPN Management System Transfer Sets and Accessories

Vented Sets

9-Lead Transfer Set	PV900	2112342	10
6-Lead Transfer Set	PV600	2112341	10

Non-Vented Sets

9-Lead Transfer Set	PN900	2112344	10
6-Lead Transfer Set	PN600	2112343	10

Vented Micro Spike Adapter	418121	418121	50
Tamper-Resistant Clamps for TPN Bags 1 Liter or larger	2112397	2112397	500
Tamper-Resistant Clamps for TPN Bags smaller than 1 Liter	2112432	2112432	500
LCD Wall Mount	126909	126909	1
LCD Swing Arm Mount	401539	401539	1
Dual Chamber Bag Filling Set	2112415	2112415	25
TPN Bag Stand Holder	435251	435251	1
High Flow Y Adaptor Set	2112431	2112431	20

Description	Size (mL)	Container Type	Product Code	REF Number	Units per Cs
-------------	-----------	----------------	--------------	------------	--------------

3-in-1 Mixing Containers, EVA Formulation

TPN Bag with PINNACLE Compounder Compatible Connector	4000	EVA*	CP4000	2112351	20
	3000	EVA	CP3000	2112350	40
	2000	EVA	CP2000	2112349	40
	1000	EVA	CP1000	2112348	40
	500	EVA	CP0500	2112347	25
	250	EVA	CP0250	2112346	25

Dual Chamber Mixing Containers, EVA Formulation

Dual Chamber Mixing Container with PINNACLE Compounder compatible connectors	4000	EVA	USP4023	2112408	28
	3000	EVA	USP3023	2112407	28
	1500	EVA	USP1523	2112406	28

EVA is a PVC-free, DEHP-free plastic film

Windows is a registered trademark of Microsoft Corporation. Trissel's is a trademark of Lawrence A. Trissel

Description	Size (mL)	Container Type	Product Code	REF Number	Units per Cs
3-in-1 Mixing Containers, EVA Formulation					
For Use with Gravity Transfer					
TPN Bag with 3-lead Vented Transfer Set, Large Bore Tubing and Plastic Sealing Clip	3000	EVA*	S9916-10	2112365	40
	2000	EVA	S9915-10	2112364	40
	1000	EVA	S9910-10	2112363	40
TPN Bag with 2-lead Vented Transfer Set, Large Bore Tubing and Plastic Sealing Clip	3000	EVA	S9946-10	2112362	40
	2000	EVA	S9945-10	2112361	40
	1000	EVA	S9940-10	2112360	40
	500	EVA	S9941-10	2112359	40

EVA* Formulation Dual Chamber Mixing Container

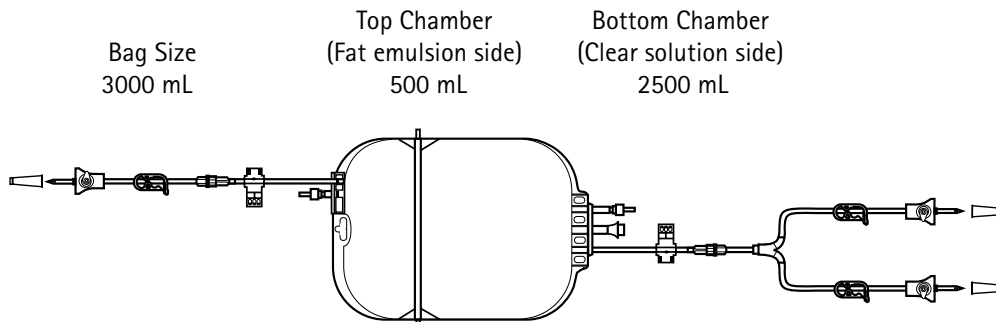

Dual Chamber Mixing Container for Gravity Transfer Y-type transfer set on large side and single lead gravity transfer set on small side	3000	USC3031	2112404	28
---	------	---------	---------	----

See the IV Fluids and Irrigation Section of the Catalog for IV Fluid Therapy Products

* EVA is a PVC-free, DEHP-free plastic film

ADMIXTURE PRODUCTS

	Size (mL)	Container Type	REF Number	Units Per Case
Admixture Products and Accessories				
IV Evacuated Container	1000	Glass/SS	S9900-10	6
	500	Glass/SS	S9901-10	12
	250	Glass/SS	S9902-10	12
PAB® Partial Additive Bag	150	PAB	S5904-52	48
		Product Code	REF Number	Units Per Case

Admixture Products and Accessories

BIG TAB® Additive Cap – extra-large, ribbed finger grip with tamper-proof feature fits	AC28	315000	100
--	------	--------	-----

28 mm bottle tops. Color: Green. Latex-free. DEHP-free. Packaged individually, sterile.

Additive Cap (nonsterile) for PAB® partial additive bag	N2140	N2140	1000
---	-------	-------	------

See the IV Fluids and Irrigation Section of the Catalog for IV Fluid Therapy Products

** SS indicates solid stopper

PAB is a latex-free, PVC-free, DEHP-free Partial Additive Bag

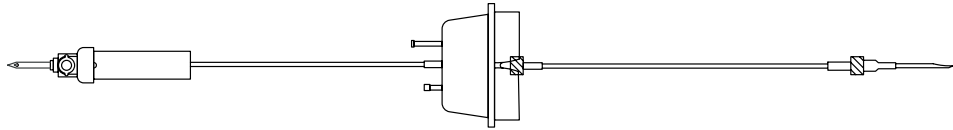
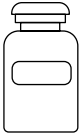
Description	Units per Case	REF Number
QC TESTER™ Whole Solution Contamination Tester		
		
Q.C. TESTER with 0.22 micron filter, Universal Spike and Soy Broth in 20 mL vial	20	QC0102
		
Extra Soy Broth in 20 mL vial	20	QC0200

See the IV Fluids and Irrigation Section of the Catalog for IV Fluid Therapy Products

NEEDLES AND SYRINGES

HYPODERMIC NEEDLES



Unique, highly automated grinding and polishing process and low-friction lubrication is designed to achieve unequalled sharpness and ease of penetration. Transparent hub design provides high visibility to detect flashback.

Designed for Patient Comfort in a Broad Array of Sizes

- Smooth surface with light silicone coating designed to minimize discomfort
- Color-coded hubs for easy identification
- Wide range of diameters and lengths
- Lengths from 1/2 in. to 4 3/4 in.
- Gauges from 18G to 27G
- Ultra-sharp, tri-beveled stainless steel designed to result in minimal pain

Material:

Stainless steel with plastic (polypropylene) hubs

Legend

RB Regular Bevel Needle
SB Short bevel Needle

Learn more about B. Braun Needles and Syringes. Visit our website at www.needlesandsyringesbbraun.com or contact Clinical and Technical Support at **1-800-854-6851**

Description	REF Number	Units Per Case
18G x 1 in.	4665118-02	1000
18G x 1 1/2 in.	4665120-02	1000
18G x 2 in.	4667123-02	1000
19G x 1 1/4 in.	4665317-02	1000
19G x 1 1/2 in. RB	4657799-02	1000
19G x 1 1/2 in. SB	4665112-02	1000
19G x 2 in.	4665511-02	1000
20G x 1 in.	4657500-02	1000
20G x 1 1/2 in.	4657519-02	1000
20G x 2 in.	4667093-02	1000
20G x 2 3/4 in.	4665791-02	1000
21G x 1 in.	4657543-02	1000
21G x 1 1/2 in.	4657527-02	1000
21G x 2 in.	4665503-02	1000
21G x 3 1/8 in.	4665465-02	1000
21G x 4 3/4 in.	4665643-02	1000
22G x 1 in.	4657659-02	1000
22G x 1 1/4 in.	4657624-02	1000
22G x 1 1/2 in.	4660021-02	1000
22G x 2 in.	4650018-02	1000
23G x 1 in.	4657667-02	1000
23G x 1 1/4 in.	4657640-02	1000
23G x 2 3/8 in.	4665600-02	1000
23G x 3 1/8 in.	4665635-02	1000
24G x 1 in.	4657675-02	1000
25G x 5/8 in.	4657853-02	1000
25G x 1 in.	9186158-02	1000
25G x 1 1/2 in.	9186166-02	1000
26G x 1/2 in.	4665457-02	1000
26G x 1 in.	4657683-02	1000
27G x 1/2 in.	4665406-02	1000
27G x 3/4 in.	4657705-02	1000
27G x 1 in.	9186174-02	1000
27G x 1 1/2 in.	9186182-02	1000
21G x 7/8 in. Blunt Cannula	9180109-02	1000
27G x 1 in. Blunt Cannula	9180117-02	1000

TUBERCULIN SYRINGES

Designed with smooth, accurate, consistent plunger travel force:

- 25 gauge and 26 gauge with detachable needles
- 30 gauge permanently attached needle version
- Minimal silicone residue
- Positive plunger stop on all sizes
- Available option - without needle

Material:

- Barrel and plunger rod: Polypropylene
- Plunger tip: Polyisoprene
- Components do not contain DEHP, PVC, or rubber tree latex

Description	REF Number	Units Per cs
1 mL TB LS	9161406V-02	1800
1 mL TB 25G x 5/8 in. DET	9161422-02	1600
1 mL TB 26G x 1/2 in. DET	9161414-02	1600
1 mL TB 30G x 1/2 in. PN	9161502SUS	2400

INSULIN SYRINGES

Advanced, premium comfort needle technology design:

- Positive plunger stop on all sizes
- 0.5 and 1 mL sizes
- 27 gauge and 30 gauge for maximum patient comfort
- Permanently attached, detachable, and without needle configurations
- Smooth, consistent plunger gliding force
- Highly transparent for better visualization

Material:

- Barrel and plunger rod: Polypropylene
- Plunger tip: Polyisoprene
- Components do not contain DEHP, PVC, or rubber tree latex

Description	Single or Pack of Ten	REF Number	Units Per cs
0.5 mL Insulin 30G x 5/16 in. PN	Single Pack	9151117SUS	2400
0.5 mL Insulin 30G x 1/2 in. PN	Single Pack	9151125SUS	2400
1 mL Insulin 30G x 5/16 in. PN	Single Pack	9151133SUS	2400
1 mL Insulin 30G x 1/2 in. PN	Single Pack	9151141SUS	2400
1mL Insulin 27G x 1/2 in. DET	Single Pack	9161732VUS	1600
1mL Insulin Syringe	Single Pack	9161708VUS	1800

Legend

- DET - Detachable Needle
- LL - Luer Lock
- LS - Luer Slip
- PN - Permanent Needle

Learn more about B. Braun Needles and Syringes. Visit our website at www.needlesandsyringesbbraun.com or contact Clinical and Technical Support at **1-800-854-6851**

NEEDLES AND SYRINGES



SYRINGES/SYRINGES WITH NEEDLES – 1 mL to 5 mL (10 mL to 100 mL on next page)

Designed for Consistent Performance

- Smooth plunger action and double-seal stopper
- High visibility – transparent barrel with bold graduations
- Secure backstop to prevent accidental plunger withdrawal
- Double seal stopper to prevent medication leakage
- Large, stable finger grips

Syringe Materials

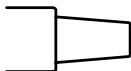
- Barrel and plunger rod: Polypropylene
- Plunger tip: Polyisoprene
- Components do not contain DEHP, PVC, or rubber tree latex

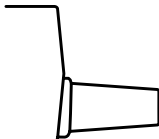
	Description	REF Number	Units Per cs
 Luer slip	3 mL LS	4610302-02	2400
	3 mL LL	4610303-02	2400
	3 mL LL 18G x 1 in.	4610304-02	1600
 Luer lock	3 mL LL 18G x 1 1/2 in.	4610305-02	1600
	3 mL LL 20G x 1 in.	4610306-02	1600
	3 mL LL 20G x 1 1/2 in.	4610307-02	1600
	3 mL LL 21G x 1 in.	4610308-02	1600
	3 mL LL 21G x 1 1/2 in.	4610309-02	1600
	3 mL LL 22G x 1 in.	4610310-02	1600
	3 mL LL 22G x 1 1/2 in.	4610311-02	1600
	3 mL LL 23G x 1 in.	4610312-02	1600
	3 mL LL 23G x 1 1/4 in.	4610313-02	1600
	3 mL LL 25G x 5/8 in.	4610314-02	1600
 Eccentric	3 mL LL 25G x 1 in.	4610315-02	1600
	3 mL LL 27G x 1/2 in.	4610316-02	1600
	5 mL LS	4610518-02	2000
	5 mL LL	4617053V-02	2000
	5 mL Eccentric	4616057V-02	2000
	5 mL LL 18G x 1 1/2 in.	4610519-02	900
	5 mL LL 20G x 1 in.	4610520-02	900
	5 mL LL 20G x 1 1/2 in.	4610521-02	900
	5 mL LL 21G x 1 in.	4610522-02	900
	5 mL LL 21G x 1 1/2 in.	4610523-02	900
5 mL LL 22G x 1 in.	4610524-02	900	
5 mL LL 22G x 1 1/4 in.	4610525-02	900	
5 mL LL 22G x 1 1/2 in.	4610526-02	900	
5 mL LL 23G x 1 in.	4610527-02	900	
5 mL LL 25G x 1 1/2 in.	4610528-02	900	
5 mL LL 27G x 1 1/2 in.	4610529-02	900	

Legend

LL - Luer Lock

LS - Luer Slip

SYRINGES/SYRINGES WITH NEEDLES – 10 mL to 100 mL (1 mL to 5 mL on previous page)

Designed for Consistent Performance

- Smooth plunger action and double-seal stopper
- High visibility – transparent barrel with bold graduations
- Secure backstop to prevent accidental plunger withdrawal
- Double seal stopper to prevent medication leakage
- Large, stable finger grips

Syringe Materials:

- Barrel and plunger rod: Polypropylene
- Plunger tip: Polyisoprene
- Components do not contain DEHP, PVC, or rubber tree latex

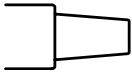
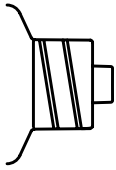
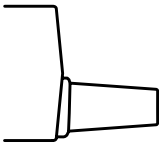
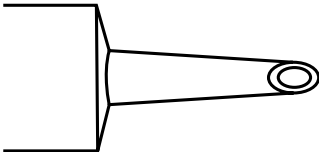
	Description	REF Number	Units Per cs
	10 mL LS	4611030-02	1200
	10 mL LL	4617100V-02	1200
	10 mL Eccentric	4616103V-02	1200
	10 mL LL 18G x 1 inch	4611031-02	900
	10 mL LL 18G x 1½ in.	4611033-02	900
	10 mL LL 20G x 1½ in.	4611034-02	900
	10 mL LL 21G x 1 in.	4611035-02	900
	10 mL LL 21G x 1½ in.	4611036-02	900
	10 mL LL 22G x 1 in.	4611037-02	900
	10 mL LL 22G x 1½ in.	4611038-02	900
	10 mL LL 23G x 1 in.	4611039-02	900
	10 mL LL 25G x 1½ in.	4611040-02	900
	20 mL LS	4612041-02	800
	20 mL LL	4617207V-02	800
	20 mL Eccentric	4616200V-02	800
	20 mL LL 21G x 1½ in.	4612042-02	800
	30 mL LS	4613043-02	600
	30 mL LL	4617304F-02	600
	30 mL Eccentric	4616308F-02	600
	50 mL LS	4615044F-02	50
	50 mL LL	4617509F-02	50
	50 mL Eccentric	4616502F-02	50
	50 mL CATHETER	4613503F-02	50
	50 mL CATHETER with Luer Adaptor	4613554F-02	50
	100 mL CATHETER with Luer Adaptor	4614003F-02	50

Legend

- LL - Luer Lock
- LS - Luer Slip

Learn more about B. Braun Needles and Syringes. Visit our website at www.needlesandsyringesbbraun.com or contact Clinical and Technical Support at **1-800-854-6851**

NEEDLES AND SYRINGES

INJEKT™ SYRINGES

Injekt syringes do not contain rubber tree latex, silicone oil, styrene, or DEHP. Manufactured only from laboratory polypropylene and polyethylene, these unique plastic syringes have a positive safety stop to help prevent accidental spills.

Accurate and economical Injekt syringes:

- Ideal for simple injections, vaccinations and more
- Compatible with all needles
- Green plunger for easy recognition of filling volumes
- Smooth, steady operation
- Also available with Sterican® needles for unmatched sharpness and patient comfort

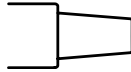
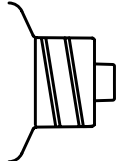
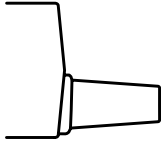
	Description	REF Number	Units Per cs
 Luer slip	Injekt 1 mL LS Syringe	9166017V-02	1800
	Injekt 1 mL LS with 25G x 5/8 in. Needle	9166033V-02	1800
	Injekt 2 mL LL Syringe	4606701V-02	2500
 Luer lock	Injekt 2 mL LS Syringe	4606027V-02	2500
	Injekt 2 mL LS with 23G x 1 1/4 in. Needle	4645022V-02	2500
	Injekt 5 mL LL Syringe	4606710V-02	2000
	Injekt 5 mL Eccentric Syringe	4606051V-02	2000
	Injekt 5 mL Eccentric with 22G x 1 1/4 in. Needle	4645057V-02	2000
 Eccentric	Injekt 10 mL LL Syringe	4606728V-02	1200
	Injekt 10 mL Eccentric Syringe	4606108V-02	1200
	Injekt 10 mL Eccentric with 21G x 1 1/2 in. Needle	4645103V-02	1200
	Injekt 20 mL LL Syringe	4606736V-02	800
	Injekt 20 mL Eccentric Syringe	4606205V-02	800
	Injekt 20 mL Eccentric with 21G x 1 1/2 in. Needle		800

Legend

LL - Luer Lock

LS - Luer Slip

INJEKT-F SYRINGE (Low Waste)

Injekt-F syringe tip prevents dead space with minimal residual volume:

- Designed to deliver virtually all costly medication
- Designed to provide accurate dosing to 0.01 mL

Description	REF Number	Units Per cs
Injekt-F 1 mL LS Syringe	9166017V	1800



Learn more about B. Braun Needles and Syringes. Visit our website at www.needlesandsyringesbbraun.com or contact Clinical and Technical Support at **1-800-854-6851**

Ready to Use IV Drug Delivery

DUPLEX® DRUG DELIVERY SYSTEM

DUPLEX, a dual-chamber IV container, is now available in five cephalosporins that cover three generations of treatment. DUPLEX, recipient of the 2002 Medical Design Excellence Award and 2003 DuPont Packaging Award, is ready to use and supports The Joint Commission compliance.

Conveniently activated at point of care, there is no need for freezing or special vials. Pre-filled drug and diluent chambers eliminate need for drug admixing and potential for associated medication errors. Not manufactured with PVC, DEHP, or natural rubber latex.

Description	Size (mL)	Container Type	Units per Case	REF Number	NDC Number
DUPLEX Drug Delivery System Cephalosporins					
1g Cefazolin for Injection USP and Dextrose Injection USP	50	DUPLEX	24	3103-11	0264-3103-11
2g Cefazolin for Injection USP and Dextrose Injection USP	50	DUPLEX	24	3105-11	0264-3105-11
750 mg CefUROXime for Injection USP and Dextrose Injection USP	50	DUPLEX	24	3112-11	0264-3112-11
1.5g CefUROXime for Injection USP and Dextrose Injection USP	50	DUPLEX	24	3114-11	0264-3114-11
1g Cefoxitin for Injection and Dextrose Injection	50	DUPLEX	24	3123-11	0264-3123-11
2g Cefoxitin for Injection and Dextrose Injection	50	DUPLEX	24	3125-11	0264-3125-11
1g Ceftazidime for Injection USP and Dextrose Injection USP	50	DUPLEX	24	3143-11	0264-3143-11
2g Ceftazidime for Injection USP and Dextrose Injection USP	50	DUPLEX	24	3145-11	0264-3145-11
1g CefTRIaxONE for Injection and Dextrose Injection	50	DUPLEX	24	3153-11	0264-3153-11
2g CefTRIaxONE for Injection and Dextrose Injection	50	DUPLEX	24	3155-11	0264-3155-11
1g Cefotetan for Injection USP and Dextrose Injection USP	50	DUPLEX	24	3173-11	0264-3173-11
2g Cefotetan for Injection USP and Dextrose Injection USP	50	DUPLEX	24	3175-11	0264-3175-11
1g Cefepime for Injection USP and Dextrose Injection USP	50	DUPLEX	24	3193-11	0264-3193-11
2g Cefepime for Injection USP and Dextrose Injection USP	50	DUPLEX	24	3195-11	0264-3195-11

Description	Size (mL)	Container Type	Units per Case	REF Number	NDC Number
-------------	-----------	----------------	----------------	------------	------------

PRE-MIXED PHARMACEUTICALS

Heparin Sodium Injections

20,000 Units Heparin in 5% Dextrose Injection, 40 Units/mL	500	EXCEL®	24	P5671	0264-9567-10
40 Units/mL (Canada)	500	EXCEL	24	P5671-00	—
25,000 Units Heparin in 5% Dextrose Injection, 50 Units/mL	500	EXCEL	24	P5771	0264-9577-10
50 Units/mL (Canada)	500	EXCEL	24	P5771-00	—
100 Units/mL	250	EXCEL	24	P5872	0264-9587-20
100 Units/mL (Canada)	250	EXCEL	24	P5872-00	—
1,000 Units Heparin in 0.9% NaCl Injection, 2 Units/mL	500	EXCEL	24	P8721	0264-9872-10
2 Units/mL (Canada)	500	EXCEL	24	P8721-00	—

Lidocaine Hydrochloride and 5% Dextrose Injection USP

8 mg/mL:

0.8% Lidocaine Hydrochloride and 5% Dextrose Injection USP (2 g)	250	EXCEL	24	P5982	0264-9598-20
--	-----	-------	----	-------	--------------

4 mg/mL:

0.4% Lidocaine Hydrochloride and 5% Dextrose Injection USP (2 g)	500	EXCEL	24	P5941	0264-9594-10
(1 g)	250	EXCEL	24	P5942	0264-9594-20

IV Fluids & Irrigation

IV PHARMACEUTICAL PRODUCTS

Description	Size (mL)	Container Type	Units per Case	REF Number	NDC Number
PRE-MIXED PHARMACEUTICALS					
Metronidazole Injection USP					
Metronidazole Injection USP 500 mg (5 mg/mL)	100	PAB®	24	D5353-5224	0264-5535-32
Theophylline in 5% Dextrose Injection USP					
400 mg: 0.08% Theophylline in 5% Dextrose Injection USP (0.8 mg/mL)	500	EXCEL	24	P5541	0264-9554-10

** SS indicates solid stopper

PAB is a Latex-free, PVC-free, DEHP-free Partial Additive Bag

EXCEL is a Latex-free, PVC-free, DEHP-free IV container

Description	Size (mL)	Container Type	REF Number	Units per Case
Empty IV Containers				
IV Evacuated Container	1000	Glass/SS	S9900-10	6
	500	Glass/SS	S9901-10	12
	250	Glass/SS	S9902-10	12
PAB® Partial Additive Bag	150	PAB	S5904-52	48

Description	Product Code	REF Number	Units per Case
Admixture Products and Accessories			
BIG TAB® Additive Cap – extra-large, ribbed finger grip with tamper-proof feature fits 28 mm bottle tops. Packaged individually, sterile.	AC28	315000	100
Additive Cap (nonsterile) for PAB® partial additive bag		N2140	1000

The PINNACLE® TPN Management System, Accessories, and Mixing Containers appear in the Admixture Section of the Catalog

** SS indicates Solid Stopper
PAB is a Latex-free, PVC-free, DEHP-free IV container

IV NUTRITION PRODUCTS

Description	Size (mL)	Container Type	Units per Case	REF Number	NDC Number
Standard Amino Acid Injections*					
15% Amino Acids Injection	1000	Glass/SS	6	S3200-SS	0264-3200-55
10% FreAmine III (Amino Acid Injection)	1000	Glass/SS	6	S9010-SS	0264-9010-55
Specialty Amino Acid Injections*					
6.9% FreAmine HBC® (Amino Acid Injection)	750 mL fill in 1000 mL container	Glass/SS	6	S9350-58SS	0264-9350-55
ProcalAmine® (3% Amino Acid and 3% Glycerin Injection with Electrolytes)	1000	Glass/SS	6	S9050	0264-1915-07
5.4% NephroAmine® (Essential Amino Acid Injection)	250	Glass/SS	12	S9092-SS	0264-1909-55
HepatAmine® (8% Amino Acid Injection)	500	Glass/SS	6	S9371-SS	0264-9371-55
TrophAmine® (6% Amino Acid Injection)	500	Glass/SS	12	S9361-SS	0264-9361-55
TrophAmine (10% Amino Acid Injection)	500	Glass/SS	6	S9341-SS	0264-9341-55
Intravenous Fat Emulsions					
Nutrilipid 20% (Intravenous Fat Emulsion)	1000	Flexible Plastic	8	S4600	0264-4460-00
	500	Flexible Plastic	12	S4601	0264-4460-10
	250	Flexible Plastic	12	S4603	0264-4460-30

** SS indicates Solid Stopper

* See Electrolyte Concentration Charts for electrolyte profile of each solution

Description	Size (mL)	Container Type	Units per Case	REF Number	NDC Number
Concentrated Dextrose Injections					
70% Dextrose Injection USP	1000	Glass/SS	6	S1290-SS	0264-1290-55
Sterile Water Injections					
Sterile Water for Injection USP	1000	EXCEL®	12	L8500	0264-7850-00
	500	EXCEL	24	L8501-01	0264-7850-10
	250	EXCEL	24	L8502	0264-7850-20
Sterile Water for Injection USP	3000	Titan XL™	4	S8506	0264-7385-60
	2000	Titan XL	4	S8505	0264-7385-50
Parenteral Nutrition Additives*					
Concentrated Potassium Chloride Injection USP (2mEq K ⁺ /mL)	250	Glass/SS	12	S9402-11	0264-1940-20
Hyperlyte® CR Multi-Electrolyte Concentrate in Pharmacy Bulk Package, 20 mL/Dose	250	Glass/SS	12	S9432	0264-1943-20

IV Fluids & Irrigation

* See Electrolyte Concentration Charts for electrolyte profile of each solution
 ** SS indicates solid stopper
 EXCEL is a Latex-free, PVC-free, DEHP-free IV container

Description	Size (mL)	Container Type	Units per Case	REF Number	NDC Number
GENERAL PURPOSE IV SOLUTIONS					
Dextrose Injections					
5% Dextrose Injection USP	1000	EXCEL®	12	L5100	0264-7510-00
	500	EXCEL	24	L5101	0264-7510-10
	250	EXCEL	24	L5102	0264-7510-20
	100 Fill in 150 mL	PAB®	64	S5104-5264	0264-1510-32
	50 Fill in 100 mL	PAB	84	S5104-5384	0264-1510-31
	25 Fill in 100 mL	PAB	116	S5104-5410	0264-1510-36
10% Dextrose Injection USP	1000	EXCEL	12	L5200	0264-7520-00
	500	EXCEL	24	L5201	0264-7520-10
	250	EXCEL	24	L5202	0264-7520-20

Dextrose and Sodium Chloride Injections*					
2.5% Dextrose and 0.45% Sodium Chloride Injection USP	1000	EXCEL	12	L6050	0264-7605-00
3.3% Dextrose and 0.30% Sodium Chloride Injection USP (Canada)	1000	EXCEL	12	L6080-00	0264-7608-00
	500	EXCEL	24	L6081-00	0264-7608-10
5% Dextrose and 0.9% Sodium Chloride Injection USP	1000	EXCEL	12	L6100	0264-7610-00
	500	EXCEL	24	L6101	0264-7610-10
5% Dextrose and 0.45% Sodium Chloride Injection USP	1000	EXCEL	12	L6120	0264-7612-00
	500	EXCEL	24	L6121	0264-7612-10
	250	EXCEL	24	L6122	0264-7612-20
5% Dextrose and 0.33% Sodium Chloride Injection USP	1000	EXCEL	12	L6140	0264-7614-00
	500	EXCEL	24	L6141	0264-7614-10
5% Dextrose and 0.20% Sodium Chloride Injection USP	1000	EXCEL	12	L6160	0264-7616-00
	500	EXCEL	24	L6161	0264-7616-10
	250	EXCEL	24	L6162	0264-7616-20
10% Dextrose and 0.45% Sodium Chloride Injection USP	1000	EXCEL	12	L6220	0264-7622-00
10% Dextrose and 0.20% Sodium Chloride Injection USP	250	EXCEL	24	L6232	0264-7623-20

* See Electrolyte Concentration Charts for electrolyte profile of each solution

** SS indicates solid stopper

PAB is a Latex-free, PVC-free, DEHP-free Partial Additive Bag

EXCEL is a Latex-free, PVC-free, DEHP-free IV container

IV SOLUTIONS

Description	Size (mL)	Container Type	Units per Case	REF Number	NDC Number
GENERAL PURPOSE IV SOLUTIONS					
Ringer's Injection USP	1000	EXCEL®	12	L7800	0264-7780-00
Lactated Ringer's Injections*					
Lactated Ringer's Injection USP	1000	EXCEL	12	L7500	0264-7750-00
	500	EXCEL	24	L7501	0264-7750-10
	250	EXCEL	24	L7502	0264-7750-20
5% Dextrose in Lactated Ringer's Injection	1000	EXCEL	12	L7510	0264-7751-00
	500	EXCEL	24	L7511	0264-7751-50
Sodium Chloride Injections*					
0.45% Sodium Chloride Injection USP	1000	EXCEL	12	L8020	0264-7802-00
	500	EXCEL	24	L8021	0264-7802-10
0.9% Sodium Chloride Injection USP	1000	EXCEL	12	L8000	0264-7800-00
	500	EXCEL	24	L8001	0264-7800-10
	250	EXCEL	24	L8002	0264-7800-20
	100 mL Fill in 150 mL	PAB®	64	S8004-5264	0264-1800-32
	50 mL Fill in 100 mL	PAB	84	S8004-5384	0264-1800-31
	25 mL Fill in 100 mL	PAB	116	S8004-5410	0264-1800-36
3% Sodium Chloride Injection USP (Hypertonic)	500	EXCEL	24	L8051	0264-7805-10
5% Sodium Chloride Injection USP (Hypertonic)	500	EXCEL	24	L8061	0264-7806-10

* See Electrolyte Concentration Charts for electrolyte profile of each solution

** SS indicates solid stopper

PAB is a Latex-free, PVC-free, DEHP-free Partial Additive Bag

EXCEL is a Latex-free, PVC-free, DEHP-free IV container

Description	Size (mL)	Container Type	Units per Case	REF Number	NDC Number
GENERAL PURPOSE IV SOLUTIONS					
Potassium Chloride in 5% Dextrose Injections*					
0.15% Potassium Chloride in 5% Dextrose Injection USP (20 mEq K ⁺ /liter)	1000	EXCEL®	12	L6250	0264-7625-00
Potassium Chloride in 5% Dextrose and 0.45% Sodium Chloride Injections*					
0.075% Potassium Chloride in 5% Dextrose and 0.45% Sodium Chloride Injection USP (10 mEq K ⁺ /liter)	1000	EXCEL	12	L6340	0264-7634-00
0.15% Potassium Chloride in 5% Dextrose and 0.45% Sodium Chloride Injection USP (20 mEq K ⁺ /liter)	1000	EXCEL	12	L6350	0264-7635-00
0.22% Potassium Chloride in 5% Dextrose and 0.45% Sodium Chloride Injection USP (30 mEq K ⁺ /liter)	1000	EXCEL	12	L6360	0264-7636-00
0.30% Potassium Chloride in 5% Dextrose and 0.45% Sodium Chloride Injection USP (40 mEq K ⁺ /liter)	1000	EXCEL	12	L6380	0264-7638-00
Potassium Chloride in 5% Dextrose and 0.33% Sodium Chloride Injection*					
0.15% Potassium Chloride in 5% Dextrose and 0.33% Sodium Chloride Injection USP (20 mEq K ⁺ /liter)	1000	EXCEL	12	L6550	0264-7655-00
Potassium Chloride in 5% Dextrose and 0.20% Sodium Chloride Injection*					
0.15% Potassium Chloride in 5% Dextrose and 0.20% Sodium Chloride Injection USP (20 mEq K ⁺ /liter)	1000 250	EXCEL EXCEL	12 24	L6450 L6452	0264-7645-00 0264-7645-20
Potassium Chloride in 5% Dextrose and 0.9% Sodium Chloride Injection*					
0.15% Potassium Chloride in 5% Dextrose and 0.9% Sodium Chloride Injection USP (20 mEq K ⁺ /liter)	1000	EXCEL	12	L6520	0264-7652-00
Potassium Chloride in 0.9% Sodium Chloride Injection*					
0.15% Potassium Chloride in 0.9% Sodium Chloride Injection USP and 0.9% Sodium Chloride Injection USP (20 mEq K ⁺ /liter)	1000	EXCEL	12	L8650	0264-7865-00

IV Fluids & Irrigation

* See Electrolyte Concentration Charts for electrolyte profile of each solution
EXCEL is a Latex-free, PVC-free, DEHP-free IV container

Description	Size (mL)	Container Type	Units per Case	REF Number	NDC Number
Isolyte® MULTI-ELECTROLYTE IV SOLUTIONS*					
Isolyte P (Multi-Electrolyte Injection) in 5% Dextrose	500	EXCEL	24	L7301	0264-7730-10
Isolyte S (Multi-Electrolyte Injection)	1000	EXCEL	12	L7030	0264-7703-00
Isolyte S pH 7.4 (Multi-Electrolyte Injection)	1000	EXCEL	12	L7070	0264-7707-00
	500	EXCEL	24	L7071	0264-7707-10

SPECIAL PURPOSE IV SOLUTIONS

Mannitol Injections

20% Mannitol Injection USP	500	EXCEL	24	L5781	0264-7578-10
	250	EXCEL	24	L5782	0264-7578-20

PLASMA VOLUME IV MANAGEMENT and Leukapheresis

HESPAN® (6% hetastarch in 0.9% sodium chloride injection)	500	EXCEL	12	L6511	0264-1965-10
---	-----	-------	----	-------	--------------

Product Description	Units Per Case	REF Number	Code
---------------------	----------------	------------	------

CONTAINER ACCESSORIES

Accessories for EXCEL® Latex-free, PVC-free, DEHP-free, IV Containers

Universal Graduation Tape for 1 Liter	1000	N5400	N5400
Universal Graduation Tape for 0.5 Liter	1000	N5401	N5401

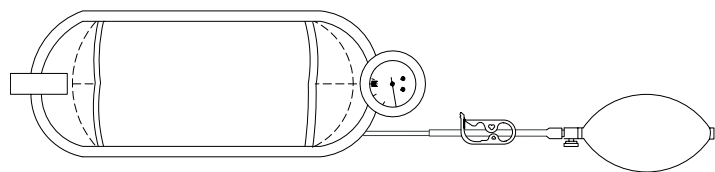

Pressure Administration Cuff for EXCEL Container	1	N5062	N5062
Additive Cap (nonsterile) for PAB® Latex-free, PVC-free, DEHP-free Bags	1000	N2140	N2140

* See Electrolyte Concentration Charts for electrolyte profile of each solution
EXCEL is a Latex-free, PVC-free, DEHP-free IV container



IRRIGATION/UROLOGY SOLUTIONS

Description	Size (mL)	Container Type	Units per Case	REF Number	NDC Number
Irrigation/Urology Solutions					
Solutions for Irrigation in PIC™ Plastic Irrigation Containers					
0.9% Sodium Chloride Irrigation USP*	4000	PIC™	4	R5207	0264-2201-70
	2000	PIC	8	R5205-01	0264-2201-50
	1000	PIC	16	R5200-01	0264-2201-00
	500	PIC	16	R5201-01	0264-2201-10
0.9% Sodium Chloride Irrigation USP* FOR CANADA ONLY (DIN 01963937)	2000	PIC	8	R5205-00	0264-7041-00
	1000	PIC	16	R5200-00	0264-7040-00
	500	PIC	16	R5201-00	0264-7039-00
Sterile Water for Irrigation USP	4000	PIC	4	R5007	0264-2101-70
	2000	PIC	8	R5005-01	0264-2101-50
	1000	PIC	16	R5000-01	0264-2101-00
	500	PIC	16	R5001-01	0264-2101-10
Lactated Ringer's Irrigation*	4000	PIC	4	R5417	0264-2203-70
	2000	PIC	8	R5415-01	0264-2203-50
	1000	PIC	16	R5410-01	0264-2203-00
Ringer's Irrigation USP*	1000	PIC	16	R5310-01	0264-2202-00
Physiolyte® (A Physiological Irrigating Solution)*	1000	PIC	16	R5510-01	0264-2205-00
Solutions for Urologic Irrigation in Plastic Containers					
3.3% Sorbitol Irrigation	4000	PIC	4	R6017	0264-2301-70
	2000	PIC	8	R6015-01	0264-2301-50
1.5% Glycine Irrigation USP	4000	PIC	4	R6417	0264-2302-70
	2000	PIC	8	R6415-01	0264-2302-50
0.25% Acetic Acid Irrigation USP	1000	PIC	16	R6600-01	0264-2304-00
	500	PIC	16	R6601-01	0264-2304-10
5% Mannitol Irrigation	2000	PIC	8	R6515-01	0264-2303-50
Solutions for Irrigation in Plastic Flexible Containers					
0.9% Sodium Chloride Irrigation USP	3000	Titan XL™	4	R8206	0264-7388-60
	2000	Titan XL	4	R8205	0264-7388-50
Sterile Water for Irrigation USP	3000	Titan XL	4	R8006	0264-7386-60
	2000	Titan XL	4	R8005	0264-7386-50
Lactated Ringer's Irrigation	3000	Titan XL	4	R8306	0264-7389-60
Solutions for Urologic Irrigation in Plastic Flexible Containers					
1.5% Glycine Irrigation USP	3000	Titan XL	4	R8406	0264-7390-60
Balanced Salt Solution in Solid Stopper Glass Container					
Balanced Salt Solution	500	Glass/SS**	12	S2514-10	0264-2514-10

** SS indicates solid stopper

Description	Product Code	REF Number	Units Per cs
-------------	--------------	------------	--------------

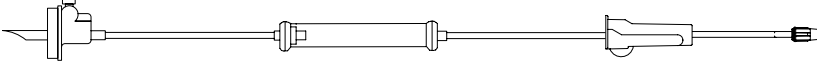
Irrigation/Urology Sets for PIC™ Plastic Irrigation Containers

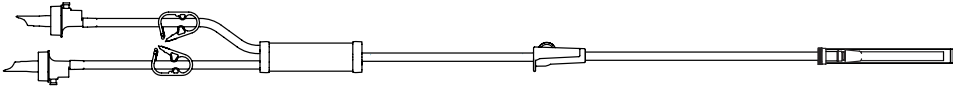
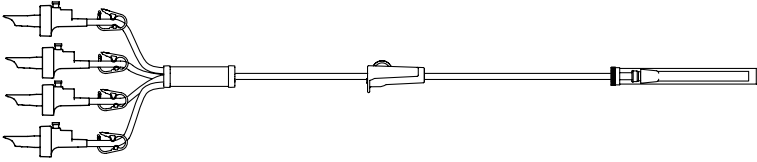
 Cysto Post-Operative Irrigation Set, UniSpike™ Connector, 0.188 in. ID tubing, on/off clamp, 4½ in. distal flexible connector. Latex-free. Length: 80 in. (203.2 cm)	V4500	V4500	20
 Uni-Spike Connector, 0.188 in. ID tubing, drip chamber, roller clamp, distal Foley catheter connector. Latex-free. Length: 71 in. (180 cm)	V4508	V4508	20
 UniSpike Connector, 0.188 in. ID tubing, drip chamber, roller clamp, distal flexible connector with a 4½ in. distal flexible connector. Latex-free. Length: 79 in. (200.7 cm)	313005	313005	10
 SuperSet™ Two-Bottle Irrigation Set, Two UniSpike Connectors, 0.281 in. ID large bore tubing, two on/off clamps, drip chamber, roller clamp, 4½ in. distal flexible connector. Latex-free. Length: 94 in. (238.8 cm)	313000	313000	10
 SuperSet Four-Bottle Irrigation Set, Four UniSpike Connectors, manifold, 0.281 in. ID large bore tubing, four on/off clamps, drip chamber, roller clamp, 4½ in. distal flexible connector. Latex-free. Length: 97 in. (246.4 cm)	313001	313001	10

Irrigation/Urology Sets Compatible with Flexible Irrigation Bags

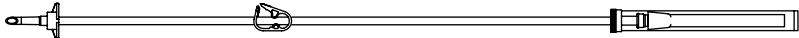
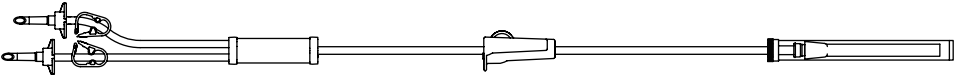
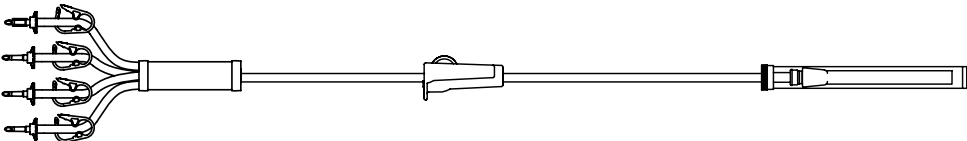
 Continuous Overhead Irrigation Set, non-vented spike, 0.188 in. ID tubing, drip chamber, roller clamp, 4½ in. distal flexible connector. Latex-free. Length: 82 in. (208.3 cm)	V4608-20	V4608-20	20
 T.U.R./Cysto Set non-vented spike, 0.281" ID large bore tubing, on/off clamps clamp, 4½ in. distal flexible connector. Latex-free. Length: 80 in. (203.20cm)	313002	313002	10
 Two-Bag Irrigation Set, two non-vented spikes, 0.281 in. ID large bore tubing, two on/off clamps, drip chamber, roller clamp, 4½ in. distal flexible connector. Latex-free. Length: 94 in. (238.8 cm)	313003	313003	10
 Four-Bag Irrigation Set, four non-vented spikes, four on/off clamps, manifold, roller clamp, 0.281 in. ID large bore tubing, 4½ in. distal flexible connector. Latex-free. Length: 96 in. (243.8 cm)	313004	313004	10

IV Fluids & Irrigation

IRRIGATION/UROLOGY SETS

Description	Product Code	REF Number	Units Per cs
-------------	--------------	------------	--------------

Irrigation/Urology Sets and Accessories

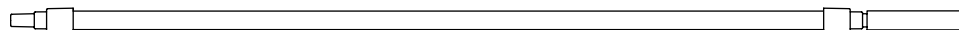

T.U.R. Irrigation Connecting Set, proximal male connector, 0.281 in. ID large bore tubing, 4 1/2 in. distal flexible connector. Latex-free. Length: 36 in. (91.4 cm)

V4031

V4031

20

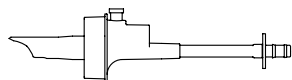

PIC™ Irrigation Container Spike Adapter – UniSpike™ adapter for B. Braun PIC® plastic irrigation container. Permits the connection of a non-vented irrigation bag spike to a plastic irrigation container.

N2150

N2150

50

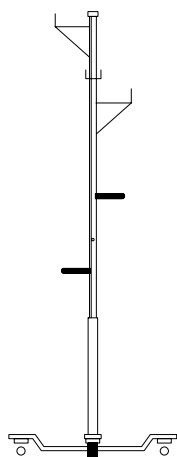

SAF-T-POLE™ Irrigation Tower,
For arthroscopic, T.U.R. and other surgeries with large fluid requirements.

N7560

N7560

1

Saf-T-Pole is a trademark of American Medical Manufacturing Inc.

Prontosan® Wound Irrigation Solution and Wound Gel



Prontosan from B. Braun because . . . Only a Clean Wound Can Heal

Wound bed preparation remains a fundamental, yet critical, aspect of wound management . . .

- A unique surface active wound cleanser setting a NEW STANDARD to help reduce necrotic burden, control exudate and remove foreign materials that impede healing
- **Prontosan Wound Irrigation Solution** and **Prontosan Wound Gel** may be used together or independently
- Two effective ingredients combined to maximize cleansing power: PHMB and Betaine
 - **PHMB (Polyhexanide)** functions as a preservative (also found in contact lens solution) that inhibits the growth of microorganisms within the product
 - **Betaine (Surfactant)** is a surface-active cleanser that provides immediate debridement
- Applied directly from the 350 mL bottle providing selective mechanical debridement at 7 PSI
- Easy to use – no further preparation required
- Apply at every dressing change, or per your facility's protocol
- Economical 28-day shelf life after opening

Wound Care

Description	HCPCS Code	REF Number	Units Per cs
Prontosan Wound Irrigation Solution			
350 mL bottle	A6260	400441	10
40 mL Ampoule (20 boxes of six each)	A6260	400440	120
Prontosan Wound Gel			
30 mL bottle	A6248	400560	20
DAPA #	SP0200-09H0037		
FSS #	V797P-4269B		

Learn more. Watch educational video. Request a sample. Visit our website at www.ProntosanWoundCare.com or contact Clinical/Technical Support at **1-800-854-6851**

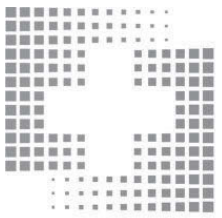

C A P S®
delivering solutions™
 A B. Braun Company

CAPS® Central Admixture Pharmacy Services, Inc.

As the nation's number one provider of custom compounded PN, CAPS is the largest network of outsourcing admixture pharmacies. CAPS delivers PN, Cardioplegia and other sterile preparations to a dynamic and challenging pharmacy environment. State-licensed and FDA-registered, CAPS pharmacies make over 300,000 local deliveries annually. With state-of-the-art compounding technology, electronic ordering and the most comprehensive quality program in the industry, CAPS pharmacies operate 365 days a year dispensing labeled, patient-specific and anticipatory IV prescriptions to health system pharmacy customers.

Services.

Nutrition Services

- Adult TPN
- Neonatal TPN
- IV Glutamine
- ProcalAmine® (3% Amino Acid and 3% Glycerin Injection with Electrolytes)

Cardioplegia

- Amino Acid Enriched Cardioplegia
- CPD/Tromethamine Cardioplegia Solution
- Microplegia with Adenocaine® Patented Technology

CRRT

- Sodium Bicarbonate
- Sodium Citrate

Controlled Substances

- IV
- Epidurals

Oxytocin and other drug delivery solutions

Prefilled Anesthesia Syringes

Quality.

- FDA-registered
- Licensed in all 50 states
- State-of-the-art clean room environments
- Beyond use dating protocols
- Quality assurance documentation/reporting
- Personnel training and education
- Environmental monitoring

Efficiency.

- **Saves Time—**
 Lets you focus on other important responsibilities, such as medication error reduction and pharmacy interventions
- **Reduces Labor Requirements—**
 Lets you redeploy personnel to patient care or new pharmacy services

Cost Savings.

- Reduces supply expenses
- Reduces labor requirements
- Reduces inventory carrying cost
- Reduces waste

CAPS Locations, Nationwide

Atlanta	Houston	New York
Birmingham	Kansas City	Orlando
Boston	Las Vegas	Philadelphia
Chicago	Lehigh Valley	Phoenix
Cleveland	Los Angeles	Pittsburgh
Connecticut	Maryland	San Diego
Dallas	Miami	San Francisco
Denver	New Orleans	Seattle
Detroit		

Learn more about the advantages of CAPS. Tour a CAPS facility. Contact us at **800-853-6498**, or on the web at **www.capspharmacy.com**

Adenocaine is a registered trademark of Hibernation Therapeutics;

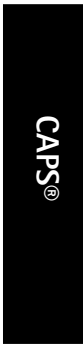

Electrolyte Concentration Chart

Product Code	Description	Milliequivalents per liter*										pH EXCEL	Calc. Osmolarity mOsmol/L			
		Na ⁺	K ⁺	Ca ⁺⁺	Mg ⁺⁺	Cl ⁻	HPO ₄ ⁻	Acce- tate	Lac- tate	Cit- rate	Glu- conate					
L6050, 1	2.5% Dextrose and 0.45% NaCl Inj. USP	77				77									4.6 (3.5-6.5)	280
L6080-00	3.3% Dextrose and 0.3% NaCl Inj. USP	51				51									4.5 (3.5-6.5)	270
L6081-00	3.3% Dextrose and 0.3% NaCl Inj. USP	51				51									4.5 (3.5-6.5)	270
L6100, 1	5% Dextrose and 0.9% NaCl Inj. USP	154				154									4.4 (3.5-6.5)	560
L6120, 1, 2	5% Dextrose and 0.45% NaCl Inj. USP	77				77									4.4 (3.5-6.5)	405
L6140, 1	5% Dextrose and 0.33% NaCl Inj. USP	56				56									4.4 (3.5-6.5)	365
L6160, 1, 2	5% Dextrose and 0.20% NaCl Inj. USP	34				34									4.4 (3.5-6.5)	320
L6220	10% Dextrose and 0.45% NaCl Inj. USP	77				77									4.3 (3.5-6.5)	660
L6232	10% Dextrose and 0.20% NaCl Inj. USP	34				34									4.3 (3.5-6.5)	575
L6250	0.15% KCl in 5% Dextrose Inj. USP		20												4.3 (3.5-6.5)	295
L6280	0.30% KCl in 5% Dextrose Inj. USP		40												4.3 (3.5-6.5)	330
L8650	0.15% KCl in 0.9% NaCl Inj.	154	20							174					5.6 (3.5-6.5)	350
L6520	0.15% KCl in 5% Dextrose and 0.9% NaCl Inj. USP	154	20							174					4.4 (3.5-6.5)	600
L6340	0.075% KCl in 5% Dextrose and 0.45% NaCl Inj. USP	77	10							87					4.4 (3.5-6.5)	425
L6350	0.15% KCl in 5% Dextrose and 0.45% NaCl Inj. USP	77	20							97					4.4 (3.5-6.5)	445
L6360	0.22% KCl in 5% Dextrose and 0.45% NaCl Inj. USP	77	30							107					4.4 (3.5-6.5)	465
L6380	0.30% KCl in 5% Dextrose and 0.45% NaCl Inj. USP	77	40							117					4.4 (3.5-6.5)	490
L6440	0.75% KCl in 5% Dextrose and 0.20% NaCl Inj. USP	34	10							44					4.4 (3.5-6.5)	340
L6450, 1	0.15% KCl in 5% Dextrose and 0.20% NaCl Inj. USP	34	20							54					4.4 (3.5-6.5)	360
L6460	0.22% KCl in 5% Dextrose and 0.20% NaCl Inj. USP	34	30							64					4.4 (3.5-6.5)	390
L6480	0.30% KCl in 5% Dextrose and 0.20% NaCl Inj. USP	34	40							74					4.4 (3.5-6.5)	400
L6550	0.15% KCl in 5% Dextrose and 0.33% NaCl Inj. USP	56	20							76					4.4 (3.5-6.5)	405
L6632	0.15% KCl in 10% Dextrose and 0.20% NaCl Inj. USP	34	20							54					4.4 (3.5-6.5)	615
L7030	Isolyte® S	140	5				3			98		27			6.7 (6.3-7.3)	295
L7070, 1	Isolyte S pH 7.4	141	5				3			98	1	27			7.4 (7.0-7.8)	295
L7301	Isolyte P with 5% Dextrose	23	20				3			29	3	23			5.0 (4.0-6.0)	340
L6511	HESpan® (6% hetastarch in 0.9% sodium chloride injection)	154								154					5.9	309

* All values are approximate to reflect slight solution differences between container systems. Consult current product Package Insert.
EXCEL is a Latex-free, PVC-free, DEHP-free IV Container

Clinical/Technical Support 1-800-854-6851

Electrolyte Concentration Chart

Product Code		Description	Milliequivalents per liter*						pH EXCEL	pH Glass	Calc. Osmolarity mOsmol/L
EXCEL®	Glass		Na ⁺	K ⁺	Ca ⁺⁺	Cl ⁻	HCO ₃ ⁻	Lac-tate			
L7500, 1, 2		Lactated Ringer's Injection USP	130	4	3	110		28	6.2 (6.0-7.5)		275
L7510, 1		5% Dextrose in Lactated Ringer's Injection	130	4	3	112		28	4.6 (4.0-6.0)		530
L7800		Ringer's Injection USP	147	4	4.5	156			5.8 (5.0-7.5)		310
L8000, 1, 2		0.9% Sodium Chloride Injection USP	154			154			5.6 (4.5-7.0)	5.3 (4.5-7.0)	310
L8020, 1		0.45% Sodium Chloride Injection USP	77			77			5.6 (4.5-7.0)	5.3 (4.5-7.0)	155
L8051		3% Sodium Chloride Injection USP (Hypertonic)	513			513			5.8 (4.5-7.0)		1030
L8061		5% Sodium Chloride Injection USP (Hypertonic)	856			856			5.8 (4.5-7.0)		1710
	S9402-11	Potassium Chloride Injection USP (per mL) (2 mEq K ⁺ /mL), Concentrated		2		2				4.8 (4.0-8.0)	4000

* All values are approximate to reflect slight solution differences between container systems. Consult current product Package Insert. EXCEL is a Latex-free, PVC-free, DEHP-free IV Container

Electrolyte Concentration Chart

Product Code	Description	Milliequivalents per liter*										Calc. Osmolarity mOsmol/L	Specific Gravity				
		Na ⁺	K ⁺	Ca ⁺⁺	Mg ⁺⁺	Cl ⁻	HPO ₄ ²⁻	Acetate	Lactate	Citrate	Gluconate			pH			
S3200-SS	15% Amino Acids Injection	0	0	0	0	0	0	0	0	0	0	0	0	0	5.6 (5.2-6.0)	1388	1.046
S9010-SS,	10% FreAmine® III (Amino Acid Injection)	10	24.5	3	5	<3	20 ^a	89	0	<3	7 ^c	47	0	0	6.5 (6.0-7.0)	950	1.032
S9050	ProcalAmine® (3% Amino Acid and 3% Glycerin Injection with Electrolytes)	35				41									6.8 (6.5-7.0)	735	1.019
S9092-SS	5.4% NephAmine® (Essential Amino Acid Injection)	5				<3		44							6.5 (6.0-7.0)	435	1.015
S9350-58SS	6.9% FreAmine HBC® (Amino Acid Injection)	10				<3		59.3							6.5 (6.0-7.0)	620	1.020
S9361-SS	TrophAmine® (6% Amino Acid Injection)	5				<3		54.4							5.5 (5.0-6.0)	525	1.019
S9341-SS	TrophAmine (10% Amino Acid Injection)	5				<3		97							5.5 (5.0-6.0)	875	1.032
S9371-SS	HepaAmine® (8% Amino Acid Injection)	10				<3	20 ^a	62							6.5 (6.0-6.8)	785	1.026
S9432	Hyperlyte® CR (Multi-Electrolyte Concentrate per 20 mL)	25 ^d	20 ^d	5 ^d	5 ^d	<3	30 ^d	30 ^d							5.2 (5.0-5.4)	5500	1.113
PIC™**	Description	Na ⁺	K ⁺	Ca ⁺⁺	Mg ⁺⁺	Cl ⁻	HPO ₄ ²⁻	Acetate	Lactate	Citrate	Gluconate	pH	Calc. Osmolarity mOsmol/L				
R5200-00, -1-00, -5-00	0.9% Sodium Chloride Irrigation USP	154				154						5.0 (4.5-7.0)	310				
R5310-01	Ringer's Irrigation USP	147	4	4.5		156	4					5.8 (5.0-7.5)	310				
R5410-01, 5-01, 7	Lactated Ringer's Irrigation	130	4	3		110		27	28			6.2 (6.0-7.5)	275				
R5510-01	Physiolyte® (A Physiological Irrigating Solution)	140	5		3	98					23	6.8 (6.3-7.3)	295				

* All values are approximate to reflect slight solution differences between container systems. Consult current product Package Insert.

** PIC is a Latex-free, PVC-free, DEHP-free Plastic Irrigation Container

a Equivalent to 10 mmole P/Liter; 31 mg % P

b Equivalent to 20 mmole P/Liter

c Equivalent to 3.5 mmole P/Liter

d Equivalent to 20 mmole P/Liter

General Purpose Infusion Systems

Description	Product Code	REF Number	Qty.
-------------	--------------	------------	------

Outlook® 100ES Safety Infusion System



The Outlook 100ES Safety Infusion System is designed to help prevent IV medication errors. The Outlook 100ES features an improved color display, up to 15 customizable Care Areas within the DoseGuard™ drug library along with the ability to continually display dosing limits using a novel visual display. New loading dose and bolus capabilities, hard and soft limits, RateGuard™ rate limits, clinical advisories and enhanced battery capability make the Outlook 100ES the logical choice for hospitals of any size who need a safe, reliable and easy to use Infusion pump.

Outlook 100ES Infusion Device	621-100ES	621-100ES	1
Syringe Holder	FZ0054	FZ0054	24

Outlook 200ES Safety Infusion System



The Outlook 200ES Safety Infusion System incorporates all of the newly enhanced features found in the Outlook 100ES. It also includes the patented DoseScan™ technology, which uses bar codes to help ensure that the Right Patient receives the Right Medication at the Right Dose by the authorized clinician at the point of care. New, flexible scan options allow for greater choices in meeting a hospital's bar coding needs including DoseGuard/RateGuard Override Scan, Bolus Authorization Scan, and Dual Clinician Scan for critical medications.

Outlook 200ES Infusion Device	621-200ES	621-200ES	1
Syringe Holder	FZ0054	FZ0054	24
Outlook ES Hand Held Scanner	FZ00621HHS	FZ00621HHS	1

General Purpose Infusion Systems

Description	Product Code	REF Number	Qty.
-------------	--------------	------------	------

Outlook® 300ES Safety Infusion System



The Outlook 300ES Safety Infusion System incorporates all of the features and technology found in the Outlook 200ES as well as the patented DoseCom™ feature. The DoseCom feature in the Outlook 300ES allows the transmission of real-time infusion data across the hospital's existing 802.11 a, b or g wireless network. The Outlook 300ES is also compatible with the DoseTrac® Infusion Management Software for evaluating the safety, efficiency and efficacy of your IV therapy process.

Outlook 300ES Infusion Device	621-300ES	621-300ES	1
Syringe Holder	FZ0054	FZ0054	24
Outlook ES Hand Held Scanner	FZ00621HHS	FZ00621HHS	1

Outlook 400ES Safety Infusion System



The Outlook 400ES Safety Infusion System incorporates all of the features and technology found in the Outlook 300ES plus the ability to utilize bi-directional wireless data to provide a method to customize communications for your institutions infusion therapy needs. The Outlook 400ES is also compatible with the DoseTrac Infusion Management Software for evaluating the safety, efficiency and efficacy of your IV therapy process.

Outlook 400ES Infusion Device	621-400ES	621-400ES	1
Syringe Holder	FZ0054	FZ0054	24
Outlook ES Hand Held Scanner	FZ00621HHS	FZ00621HHS	1

DoseTrac Infusion Management Software

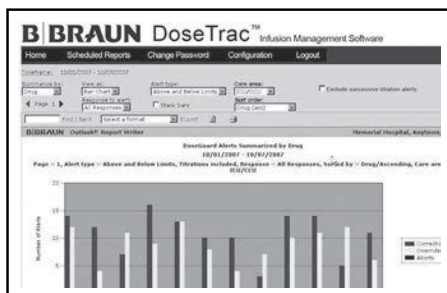

The DoseTrac Infusion Management Software (IMS) provides the ability to capture transmitted data from the Outlook 300 and Outlook 400 infusion devices to help you proactively evaluate your IV therapy program. All members of the infusion team can benefit from the real-time views and custom reporting capabilities of the DoseTrac software. Optional scheduled reporting capabilities allow authorized users to define custom report formats for automatic delivery.

DoseTrac Outlook Infusion Management System, Implementation and Clinical Analysis Program Tier 1 for Outlook ES (for up to 99 pumps)	DTESTR1	DTESTR1	1
DoseTrac Outlook Infusion Management System, Implementation and Clinical Analysis Program Tier 2 for Outlook ES (for 100 to 299 pumps)	DTESTR2	DTESTR2	1
DoseTrac Outlook Infusion Management System, Implementation and Clinical Analysis Program Tier 3 for Outlook ES (for 300 to 499 pumps)	DTESTR3	DTESTR3	1
DoseTrac Outlook Infusion Management System, Implementation and Clinical Analysis Program Tier 4 for Outlook ES (for 500 or more pumps)	DTESTR4	DTESTR4	1

Infusion Systems

PUMP SETS

Outlook® Safety Infusion System Pump Sets

Components on this page do not contain natural rubber latex.

Description	Product Code	REF Number	Units Per cs
-------------	--------------	------------	--------------

For Use with Outlook Safety Infusion System and Horizon NXT® Pumps

Outlook Pump Add-On Set

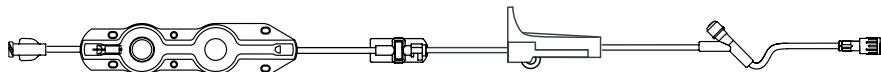

Female luer lock connector, free-flow protector clip, roller clamp, injection site 6 in. above distal end, SPIN-LOCK® connector. Priming volume: 18 mL, Length: 90 in. (229 cm)

V7400

V7400

24

Outlook Pump Administration Set

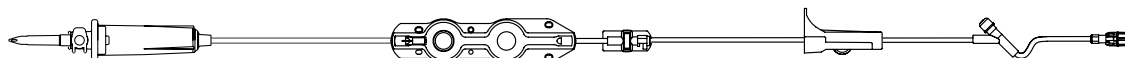

(15 drops/mL) Universal spike, free-flow protector clip, roller clamp, injection site 6 in. above distal end, SPIN-LOCK connector. Priming volume: 30 mL, Length: 132 in. (335 cm)

V7405

V7405

24

Outlook Pump ADDitIV® Primary Administration Set with Backcheck Valve

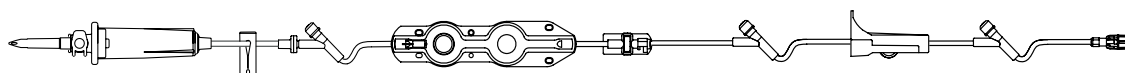

(15 drops/mL) Universal spike, slide clamp, pressure limited check valve, injection sites 105 in., 68 in. and 6 in. above distal end, free-flow protector clip, roller clamp, SPIN-LOCK connector. Priming volume: 28 mL, Length: 132 in. (335 cm)

V7410

V7410

24

Outlook Pump Filterflow® Filtered Administration Sets

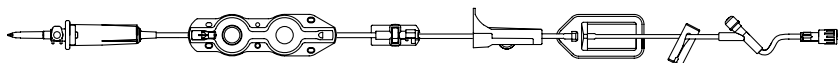

(15 drops/mL) Universal spike, free-flow protector clip, roller clamp, 0.2 micron filter, slide clamp, injection site 6 in. above distal end, SPIN-LOCK connector. Priming volume: 25 mL, Length: 115 in. (292 cm)

V7416F

352461

24

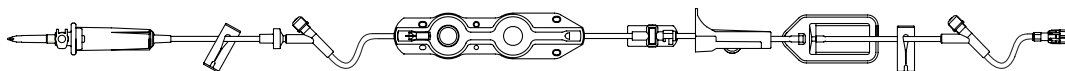

(15 drops/mL) Universal spike, slide clamp, pressure limited check valve, 2 injection sites, free-flow protector clip, roller clamp, 1.2 micron filter, slide clamp, SPIN-LOCK connector. Priming volume: 23 mL, Length: 111 in. (282 cm)

V7412F

352425

24

Outlook® Safety Infusion System Pump Sets

Components on this page do not contain natural rubber latex.

Description	Product Code	REF Number	Units Per cs
-------------	--------------	------------	--------------

For Use with Outlook Safety Infusion System and Horizon NXT® Pumps

Outlook Pump Measured Volume Solution Administration Set without Automatic Shutoff



(60 drops/mL) Non-vented spike, roller clamp, 150 mL burette chamber with 15 micron air guard filter and injection site, slide clamp, pressure limited check valve, free-flow protector clip, roller clamp, injection sites 84 in. and 6 in. above distal end, slide clamp, SPIN-LOCK® connector.
Priming volume: 26 mL, Length: 120 in. (305 cm)

375120 375120 20

Outlook Pump Measured Volume Solution Administration Set with Automatic Shutoff



(60 drops/mL) Non-vented spike, roller clamp, 150 mL burette chamber with 15 micron air guard, filter, slide clamp, pressure limited check valve, free-flow protector clip, roller clamp, injection sites 84 in. and 6 in. above distal end, SPIN-LOCK connector. Priming volume: 25 mL, Length: 120 in. (305 cm)

375118 375118 20

Outlook Pump Blood Administration Set

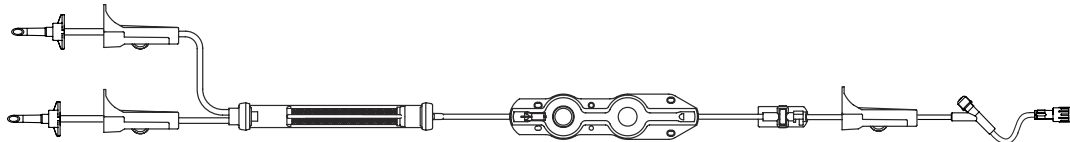

(10 drops/mL) Y-Type, non-vented spikes, two roller clamps, drip chamber with 170 micron blood filter, free-flow protector clip, roller clamp, injection site 6 in. above distal end, SPIN-LOCK connector.
Priming volume: 46 mL, Length: 131 in. (332 cm)

V7490 V7490 24

Outlook Pump Universal Spike Nitroglycerin Set - Low Adsorption with Polyethylene-lined Tubing

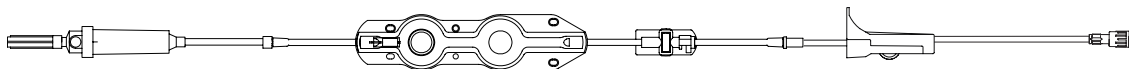

(60 drops/mL) Universal spike, free-flow protector clip, roller clamp, SPIN-LOCK connector.
Priming volume: 27 mL, Length: 135 in. (343 cm)

V7450 V7450 24

Outlook Pump Primary Administration Set with Micro Tubing for Epidural Administration

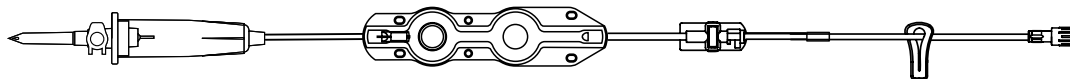

(60 drops/mL) Universal spike, green/yellow striped tubing, free-flow protector clip, slide clamp, SPIN-LOCK connector. Priming volume: 16 mL, Length: 124 in. (315 cm)

V7453 V7453 24

Infusion Systems

Outlook® Safety Infusion System Pump Sets

Components on this page do not contain natural rubber latex.

Description	Product Code	REF Number	Units Per cs
-------------	--------------	------------	--------------

For Use with Outlook Safety Infusion System and Horizon NXT® Pumps

Measured Volume Solution Administration Sets with Needleless Injection Sites, without Automatic Shutoff



(20 drops/mL) Non-vented spike, roller clamp, 150mL burette chamber without automatic shutoff, with ULTRASITE® valve and 15 micron air guard filter, slide clamp, pressure limited check valve, with ULTRASITE valve and 15 micron free-flow protector clip, roller clamp, ULTRASITE injection sites 84 in. and 6 in. above distal end, slide clamp, SPIN-LOCK® connector. Priming volume: 25 mL, Length: 120 in. (305 cm)	375038	375038	20
--	--------	--------	----

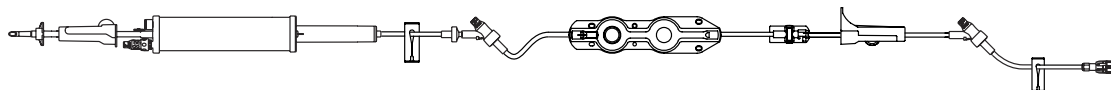

(60 drops/mL) Non-vented spike, roller clamp, 150mL burette chamber without automatic shutoff, with CARESITE® valve and 15 micron air guard filter, slide clamp, pressure limited check valve, with CARESITE valve and 15 micron free-flow protector clip, roller clamp, CARESITE injection sites 84 in. and 6 in. above distal end, slide clamp, SPIN-LOCK® connector. Priming volume: 25 mL, Length: 120 in. (305 cm)	354215	354215	20
---	--------	--------	----



(60 drops/mL) Non-vented spike, roller clamp, 150mL burette chamber with ULTRASITE valve and 15 micron air guard filter, slide clamp, pressure limited check valve, free-flow protector clip, roller clamp, ULTRASITE injection sites 84 in. and 6 in. above distal end, slide clamp, SPIN-LOCK connector. Priming volume: 25 mL, Length: 120 in. (305 cm)	375040	375040	20
--	--------	--------	----

Outlook Pump Measured Volume Solution Administration Set with ULTRASITE Needleless Injection Sites, with Automatic Shutoff



(60 drops/mL) Non-vented spike, roller clamp, 150mL burette chamber with ULTRASITE valve and 15 micron air guard filter, slide clamp, pressure limited check valve, free-flow protector clip, roller clamp, ULTRASITE injection sites 84 in. and 6 in. above distal end, SPIN-LOCK connector. Not MRI-safe. Priming volume: 25 mL, Length: 120 in. (305 cm)	375150	375150	20
---	--------	--------	----

Infusion Systems

Outlook® Safety Infusion System Pump Sets

Components on this page do not contain natural rubber latex.

Description

Product Code

REF Number

Units Per cs

For Use with Outlook Safety Infusion System and Horizon NXT® Pumps

Outlook Pump Sets with Needleless Injection Sites

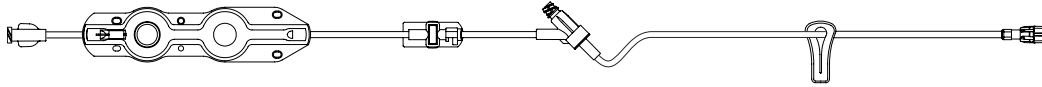

Female luer lock connector, free-flow protector clip, ULTRASITE® injection site 6 in. above distal end, slide clamp, SPIN-LOCK® connector. Priming volume: 9 mL, Length: 88 in. (224 cm)

US3110

352458

24

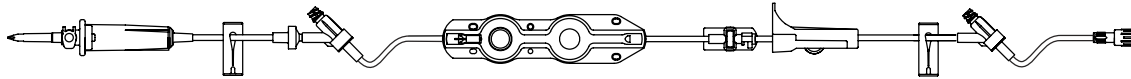

(15 drops/mL) Universal spike, slide clamp, pressure limited check valve, ULTRASITE injection sites 103 in. and 6 in. above distal end, free-flow protector clip, roller clamp, slide clamp and SPIN-LOCK connector. Priming volume: 27 mL, Length: 129 in. (328 cm)

US3130

US3130

24

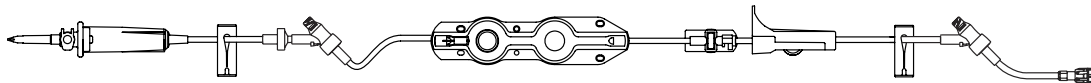

(15 drops/mL) Universal spike, slide clamp, pressure limited check valve, CARESITE™ injection sites 103 in. and 6 in. above distal end, free-flow protector clip, roller clamp, slide clamp and SPIN-LOCK connector. Priming volume: 27 mL, Length: 129 in. (328 cm)

354212

354212

24

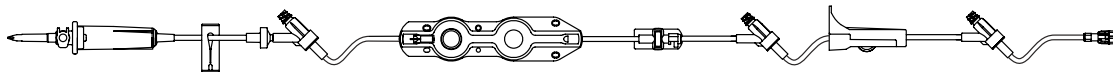

(15 drops/mL) Universal spike, slide clamp, pressure limited check valve, ULTRASITE injection sites 88 in., 68 in. and 6 in. above distal end, free-flow protector clip, roller clamp and SPIN-LOCK connector. Priming volume: 27 mL, Length: 134 in. (340 cm)

US3140

375196

24

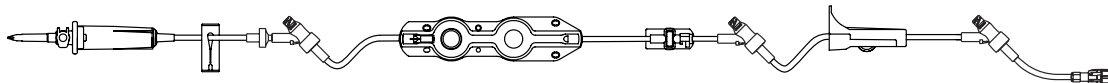

(15 drops/mL) Universal spike, slide clamp, pressure limited check valve, CARESITE injection sites 88 in., 68 in. and 6 in. above distal end, free-flow protector clip, roller clamp and SPIN-LOCK connector. Priming volume: 27 mL, Length: 134 in. (340 cm)

354213

354213

24

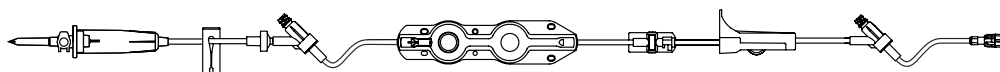

(60 drops/mL) Universal spike, slide clamp, pressure limited check valve, ULTRASITE injection sites 109 in. and 6 in. above distal end, free-flow protector clip, roller clamp, and SPIN-LOCK connector. Priming volume: 27 mL, Length: 127 in. (323 cm)

US3180

US3180

24

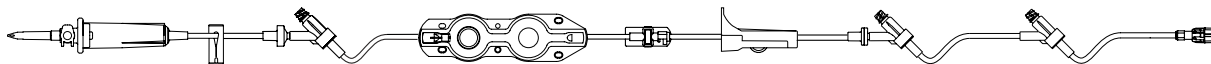

(15 drops/mL) Universal spike, slide clamp, pressure limited check valve, free-flow protector clip, roller clamp, backcheck valve, ULTRASITE injection sites 114 in., 70 in., and 6 in. above distal end, and SPIN-LOCK connector. Priming volume: 24 mL, Length: 136 in. (340 cm)

US1500HP

352520

24



(15 drops/mL) Universal spike, slide clamp, pressure limited check valve, roller clamp, free-flow protector clip, backcheck valve, ULTRASITE injection sites 94 in., 43 in. and 6 in. above distal end, and SPIN-LOCK connector. Priming volume: 25 mL, Length: 124 in. (315 cm)

US1502HP

470018

24

Infusion Systems

Outlook® Safety Infusion System Pump Sets

Components on this page do not contain natural rubber latex.

Description	Product Code	REF Number	Units Per cs
-------------	--------------	------------	--------------

For Use with Outlook Safety Infusion System and Horizon NXT® Pumps

Outlook Pump Filterflow® Filtered Sets with Needleless Injection Sites

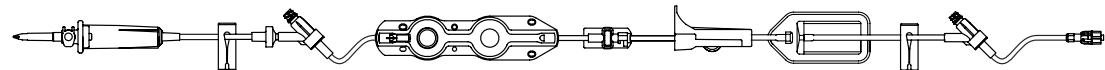

(15 drops/mL) Universal spike, slide clamp, pressure limited check valve, ULTRASITE® injection sites 86 in. and 6 in. above distal end, free-flow protector clip, roller clamp, 0.2 micron filter, slide clamp and SPIN-LOCK® connector. Priming volume: 26 mL, Length: 119 in. (302 cm)

US3169F 352442 24

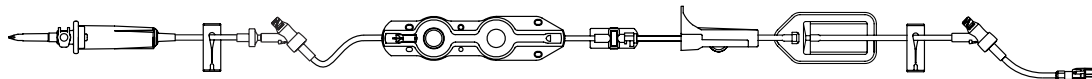

(15 drops/mL) Universal spike, slide clamp, pressure limited check valve, CARESITE injection sites 86 in. and 6 in. above distal end, free-flow protector clip, roller clamp, 0.2 micron filter, slide clamp and SPIN-LOCK connector. Priming volume: 26 mL, Length: 119 in. (302 cm)

354214 354214 24

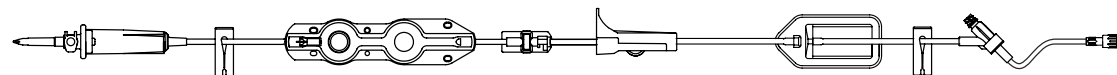

(15 drops/mL) Universal spike, slide clamp, free-flow protector clip, roller clamp, 1.2 micron filter, slide clamp, ULTRASITE injection site 6 in. above distal end, and SPIN-LOCK connector. Priming volume: 24 mL, Length: 120 in. (304 cm)

US3112F 474001 24

Outlook Pump Blood Administration Sets with Needleless Injection Site

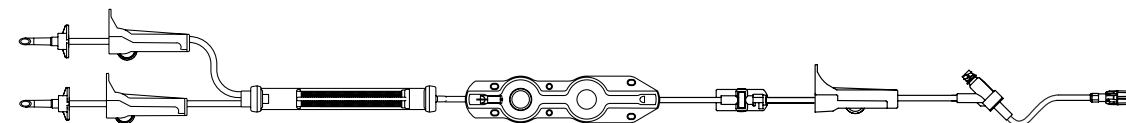

(10 drops/mL) Y-type blood set, non-vented spikes, two roller clamps, drip chamber with 170 micron blood filter, free-flow protector clip, roller clamp, ULTRASITE injection site 6 in. above distal end and SPIN-LOCK connector. Priming volume: 46 mL, Length 130 in. (330 cm)

US3120 US3120 24

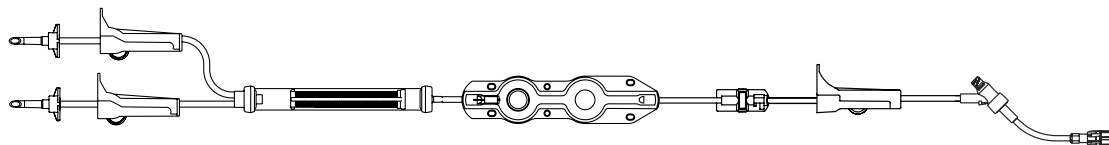

(10 drops/mL) Y-type blood set, non-vented spikes, two roller clamps, drip chamber with 170 micron blood filter, free-flow protector clip, roller clamp, CARESITE injection site 6 in. above distal end and SPIN-LOCK connector. Priming volume: 46 mL, Length 130 in. (330 cm)

354216 354216 24

ULTRABLOCK™ Set with UV Resistant Tubing

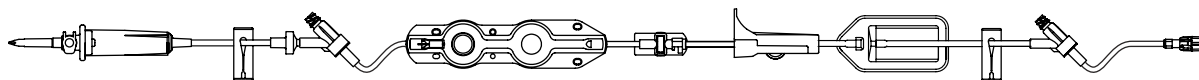

(15 drops/mL) Universal spike, free flow protector clip, roller clamp, 0.2 micron filter, slide clamp, ULTRASITE injection site 6 in. above distal end, and SPIN-LOCK connector. Priming volume: 30 mL, Length 119 in. (302 cm)

UV3169F 352472 24

Outlook® Safety Infusion System Pump Sets

Components on this page do not contain natural rubber latex.

Description

Product Code

REF Number

Units Per cs

For Use with Outlook® Safety Infusion System and Horizon NXT® Pumps

Outlook Pump ADDitIV® Primary Sets with Pressure Limited Check Valve and SAFELINE® Injection Sites

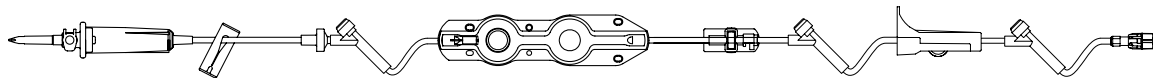

(15 drops/mL) Universal spike, slide clamp, pressure limited check valve, SAFELINE split septum injection sites 94 in., 69 in. and 6 in. above distal end, free-flow protector clip, roller clamp, SPIN-LOCK® connector. Priming volume: 24 mL, Length: 120 in. (305 cm)

NF3106

NF3106

24

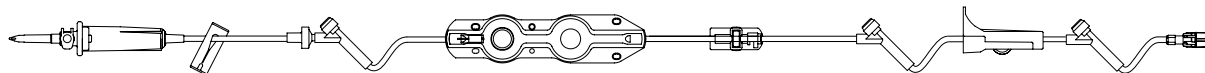

(15 drops/mL) Universal spike, slide clamp, pressure limited check valve, SAFELINE split septum injection sites 108 in., 68 in. and 6 in. above distal end, free-flow protector clip, roller clamp, SPIN-LOCK connector. Priming volume: 27 mL, Length: 134 in. (340 cm)

NF3140

NF3140

24

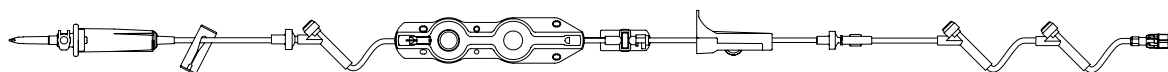

(15 drops/mL) Universal spike, slide clamp, pressure limited check valve, SAFELINE split septum injection sites 108 in., 68 in. and 6 in. above distal end, free-flow protector clip, roller clamp, backcheck valve, SPIN-LOCK connector. Priming volume: 28 mL, Length: 122 in. (310 cm)

NF3140-10

NF3140-10

24

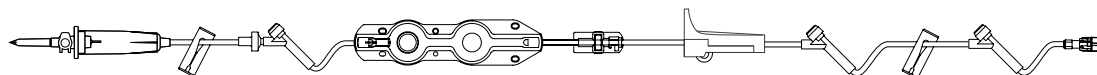

(60 drops/mL) Universal spike, pressure limited check valve, SAFELINE split septum injection sites 94 in., 68 in. and 6 in. above distal end, free-flow protector clip, roller clamp, slide clamp, SPIN-LOCK connector. Priming volume: 24 mL, Length: 120 in. (305 cm)

NF3191

NF3191

24

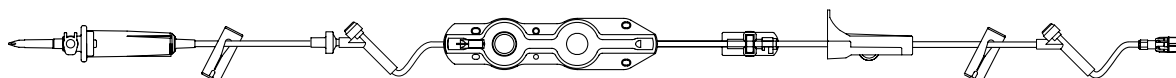

(15 drops/mL) Universal spike, slide clamp, pressure limited check valve, SAFELINE split septum injection sites 108 in. and 6 in. above distal end, free-flow protector clip, slide clamp, roller clamp, SPIN-LOCK connector. Priming volume: 25 mL, Length: 120 in. (305 cm)

NF3130

NF3130

24

Infusion Systems

Outlook® Safety Infusion System Pump Sets

Components on this page do not contain natural rubber latex.

Description	Product Code	REF Number	Units Per cs
-------------	--------------	------------	--------------

For Use with Outlook Safety Infusion System and Horizon NXT® Pumps

Outlook Pump Filterflow® Filtered Administration Set with SAFELINE® Injection Sites

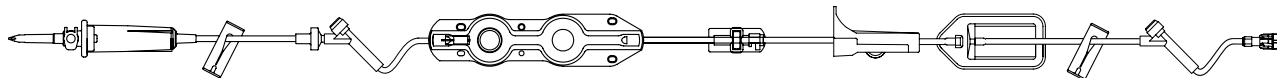

(15 drops/mL) Universal spike, pressure limited check valve, SAFELINE split septum injection sites 98 in. and 6 in. above distal end, free-flow protector clip, roller clamp, 0.2 micron filter, slide clamp, SPIN-LOCK® connector. Priming volume: 26 mL, Length: 122 in. (310 cm)	NF3169F	352430	24
---	---------	--------	----

Outlook Pump Measured Volume Solution Administration Set with SAFELINE Injection Sites, without Automatic Shutoff







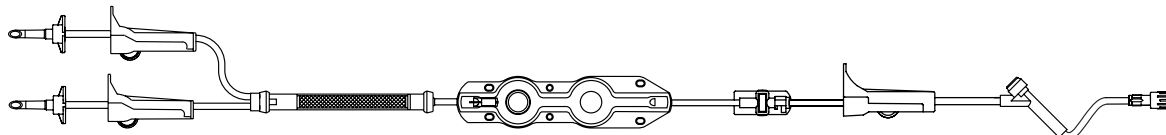





(60 drops/mL) Non-vented spike, roller clamp, 150 mL burette chamber with SAFELINE Injection site and 15 micron filter, slide clamp, pressure limited check valve, free-flow protector clip, roller clamp, SAFELINE split septum injection sites 84 in. and 6 in. above distal end, slide clamp, SPIN-LOCK connector. Priming volume: 24 mL, Length 120 in. (305 cm)	NF3115M	375122	20
--	---------	--------	----

Outlook Pump Blood Administration Set with SAFELINE Injection Site



(10 drops/mL) Y-type, non-vented spikes, two roller clamps, drip chamber with 170 micron blood filter, free-flow protector clip, roller clamp, SAFELINE split septum injection site 6 in. above distal end, SPIN-LOCK connector. Priming Volume: 46 mL, Length: 138 in. (351 cm)	NF3120	NF3120	24
--	--------	--------	----

Infusion Pumps

Description	Product Code	REF Number	Qty.
<p>Perfusor® Space Syringe Pump</p>  <p>Perfusor Space is designed for today's busy acute care hospital settings, and for use in ambulatory surgery needs in the outpatient marketplace. It provides a +-2% delivery and bolus rate accuracy for 3-60 cc syringe sizes by Tyco Monoject®, Becton Dickinson Plastipak®, and Terumo.</p>	8713030U	8713030U	1
<p>Infusomat® Space Large Volume Pump</p>  <p>With its highly customizable features, anti freeflow dedicated set integration, bolus options and occlusion pressure settings, the pump provides additional value to Space's compact design modularity.</p>	8713050U	8713050U	1
<p>Space PCA Infusion Pump System</p>  <p>B. Braun's Perfusor Space PCA Syringe Pump features advanced delivery features that offer safety and accuracy for adult and pediatric patients in any care setting where ease of use and precise medication administration are of critical importance.</p>	8713080U	8713080U	1
<p>SpaceStation</p>  <p>This product accommodates any combination of up to four Infusomat Space or Perfusor Space pumps in each housing unit. The individual units can be interconnected and require only one power cord to charge all inserted pumps. It also includes a lever-to-release universal pole clamp, tubing guides, and rotary knobs to release individual pumps. A SpaceCover Comfort is required for each stand-alone Space Station.</p>	8713140U	8713140U	1
<p>SpaceCover Comfort</p>  <p>This top portion of the SpaceStation system must always cover the uppermost segment of the SpaceStation. It also provides a handle for transport of all connected SpaceStations. Its design contains a central loudspeaker for alarm volume control with a touch pad on side. A frontal central alarm display also advises of operating alarms in the form of a red, green, or yellow light.</p>	8713145U	8713145U	1
<p>Space Pump Accessories</p>  <p>8713130</p>  <p>8713170</p>  <p>8713133</p>  <p>8713230</p>  <p>8713112C</p>	<p>Pole Clamp/Carrying Handle 8713130</p> <p>Battery Charger 8713170</p> <p>Combi Lead 8713133</p> <p>Interface Cable 8713230</p> <p>White Power Cord 8713112C</p> <p>Extension for above White Power Cord (1 meter) <i>(not shown)</i> 8713121</p> <p>Extension for above White Power Cord (1.5 meter) <i>(not shown)</i> 8713122</p> <p>Combined White Power Cord and 1 meter Extension Cord <i>(not shown)</i> 8713112C</p> <p>Spare Battery for Infusomat Space or Perfusor Space <i>(not shown)</i> 8713180</p>	<p>8713130</p> <p>8713170</p> <p>8713133</p> <p>8713230</p> <p>8713112C</p> <p>8713121</p> <p>8713122</p> <p>8713112C</p> <p>8713180</p>	<p>1</p> <p>1</p> <p>1</p> <p>1</p> <p>1</p> <p>1</p> <p>1</p> <p>1</p> <p>1</p> <p>1</p>

See page D33 for special IV pole developed for Space Infusion System Pumps

Infusomat® Space Pump Sets with ULTRASITE® Needleless IV System

Components on this page do not contain DEHP or natural rubber latex.

Description	Product Code	REF Number	Units Per cs
-------------	--------------	------------	--------------

Infusomat Space Pump IV Administration Sets

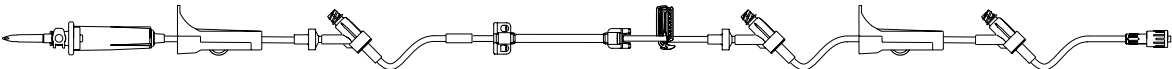
	(15 drops/mL) Universal spike, 3 ULTRASITE injection sites, 2 roller clamps, pressure limited check valve, backcheck valve, SPIN-LOCK® connector. Priming volume: 21 mL, Length: 118 in. (300 cm)	362432	362432	24
--	---	--------	--------	----

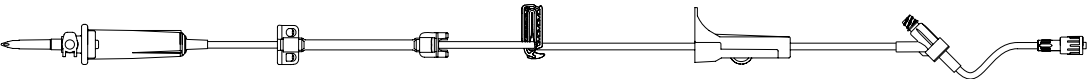
	(15 drops/mL) Universal spike, free flow protection clamp, roller clamp, ULTRASITE injection site 6 inches above distal end, SPIN-LOCK connector. Priming volume: 23 mL, Length: 120 in. (305 cm)	490031	490031	24
--	---	--------	--------	----

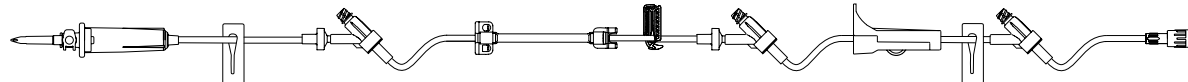
	(15 drops/mL) Universal spike, slide clamp, pressure limited check valve, three ULTRASITE injection sites 104 inches, 70 inches, and 6 inches above distal end, free flow protection clamp, backcheck valve, roller clamp, slide clamp, SPIN-LOCK connector. Priming volume: 22 mL, Length: 120 in. (305 cm)	490032	490032	24
--	--	--------	--------	----

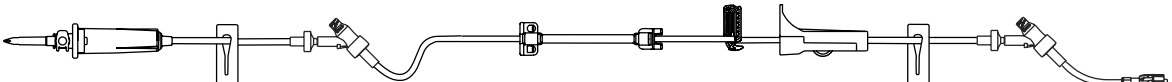
	(15 drops/mL) Universal spike, slide clamp, pressure limited check valve, two ULTRASITE injection sites 88 inches and 6 inches above distal end, free flow protection clamp, backcheck valve at distal Y-site, roller clamp, slide clamp, SPIN-LOCK connector. Priming volume: 22 mL, Length: 120 in. (305 cm)	490036	490036	24
--	--	--------	--------	----

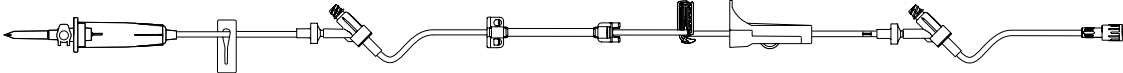
	(60 drops/mL) Universal spike, slide clamp, pressure limited check valve, two ULTRASITE injection sites 82 inches and 6 inches above distal end, free flow protection clamp, roller clamp, flow restrictor, backcheck valve at distal Y-site, SPIN-LOCK connector. Priming volume: 21 mL, Length: 115 in. (292 cm)	490042	490042	24
---	--	--------	--------	----

Infusomat Space Pump Filtered Primary Additive IV Sets

	(15 drops/mL) Universal spike, slide clamp, pressure limited check valve, two ULTRASITE injection sites 85 inches and 6 inches above distal end, free flow protection clamp, roller clamp, SUPOR® 1.2 micron air-eliminating filter, slide clamp, SPIN-LOCK connector. Priming volume: 22 mL, Length: 120 in. (305 cm)	490033	490033	24
--	--	--------	--------	----

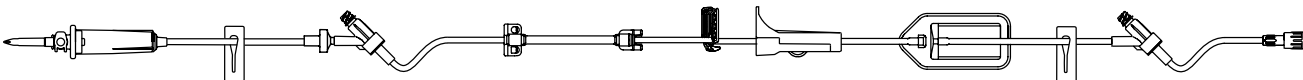
	(15 drops/mL) Universal spike, slide clamp, pressure limited check valve, two ULTRASITE injection sites 82 inches and 6 inches above distal end, free flow protection clamp, roller clamp, SUPOR 0.2 micron air-eliminating filter, slide clamp, SPIN-LOCK connector. Priming volume: 19 mL, Length: 120 in. (305 cm)	490041	490041	24
--	---	--------	--------	----

Infusomat Space Pump Burette Set without Automatic Shutoff

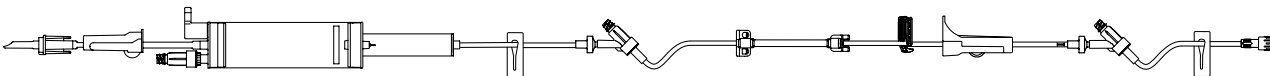
	(60 drops/mL) Non-vented spike, roller clamp, 150 mL burette with 15 micron air guard filter and ULTRASITE injection site, slide clamp, pressure limited check valve, two ULTRASITE injection sites 71 inches and 6 inches above distal end, free flow protection clamp, roller clamp, flow restrictor, backcheck valve at distal Y-site, slide clamp, SPIN-LOCK connector. Priming volume: 19 mL, Length: 120 in. (305 cm)	490034	490034	20
--	---	--------	--------	----

Infusion Systems

Infusomat® Space Pump Sets

Components on this page do not contain DEHP or natural rubber latex.

Description	Product Code	REF Number	Units Per cs
-------------	--------------	------------	--------------

Infusomat Space Pump IV Administration Set with ULTRABLOCK™ UV Resistant Tubing

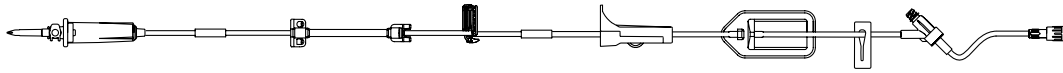

(15 drops/mL) Universal spike, free flow protection clamp, roller clamp, SUPOR® 0.2 micron air-eliminating filter, slide clamp, ULTRASITE injection site 6 inches above distal end, SPIN-LOCK connector. 490040 490040 24
Priming volume: 23 mL, Length: 119 in. (302 cm)

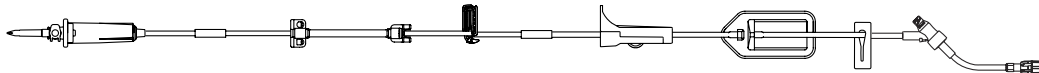

(15 drops/mL) Universal spike, free flow protection clamp, roller clamp, SUPOR® 0.2 micron air-eliminating filter, slide clamp, CARESITE® injection site 6 inches above distal end, SPIN-LOCK connector. 470119 470119 24
Priming volume: 23 mL, Length: 119 in. (302 cm)

Infusomat Space Pump Y-Type Blood Set

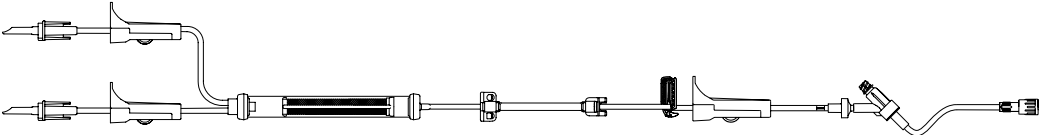

Two non-vented spikes, two roller clamps, 170 micron blood filter, free flow protection clamp, roller clamp, backcheck valve, ULTRASITE injection site 6 inches above distal end, SPIN-LOCK connector. 490043 490043 24
Priming volume: 39 mL, Length: 120 in. (305 cm)

Infusomat Space Pump Add-On Set

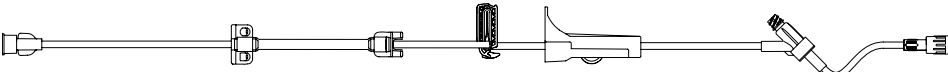

Free-flow protection clamp, roller clamp, ULTRASITE injection site 6 inches above distal end, 490030 490030 24
Priming volume: 13 mL, Length: 88 in. (224 cm)

Infusomat Space Pump Sets without Injection Sites

Infusomat Space Pump IV Administration Set

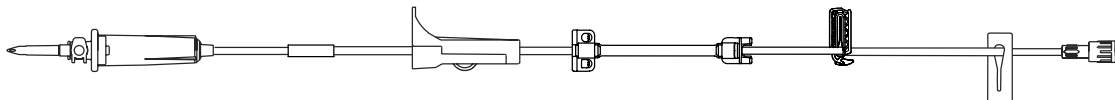

(15 drops/mL) Universal spike, roller clamp, free flow protection clamp, slide clamp, SPIN-LOCK connector. 490035 490035 24
Priming volume: 16 mL, Length: 86 in. (218 cm)

Infusomat Space Pump IV Administration Set with Microbore Tubing for Epidural Administration



(60 drops/mL) Universal spike, free flow protection clamp, slide clamp, SPIN-LOCK connector. 490038 490038 24
Priming volume: 13 mL, Length: 127 in. (323 cm)

Infusomat Space Pump Low Adsorption Set

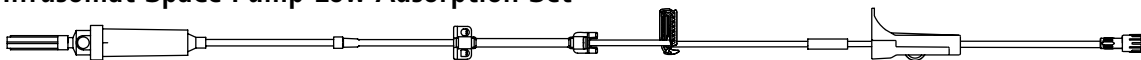

(60 drops/mL) Universal spike, free flow protection clamp, roller clamp, SPIN-LOCK connector. 490037 490037 24
Priming volume: 25 mL, Length: 136 in. (345 cm)

Infusion Systems

Infusomat® Space Pump Sets with SAFELINE® Needleless System

Description	Product Code	REF Number	Units Per cs
-------------	--------------	------------	--------------

Infusomat Space Pump Burette Sets without Automatic Shutoff

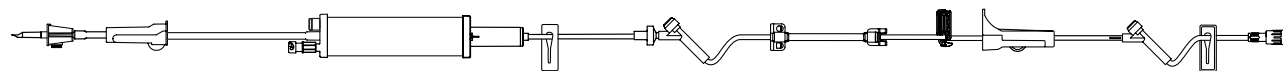

(60 drops/mL) Non-vented spike, roller clamp, 150 mL burette with 15 micron air guard filter and SAFELINE injection site, slide clamp, pressure limited check valve, flow restrictor, two SAFELINE injection sites 71 inches and 6 inches above distal end, free flow protection clamp, roller clamp, slide clamp, SPIN-LOCK connector. Components do not contain DEHP or natural rubber latex. Priming volume: 19 mL, Length: 120 in. (305 cm)

362034 362034 20

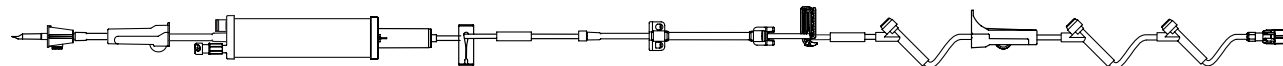

(20 drops/mL) Non-vented spike, roller clamp, 150 mL burette with 15 micron air guard filter and SAFELINE injection site, slide clamp, free flow protection clamp, three SAFELINE injection sites 62 inches, 35 inches and 6 inches above distal end, roller clamp, SPIN-LOCK connector. Components do not contain DEHP or natural rubber latex. Priming volume: 19 mL, Length: 120 in. (305 cm)

362044 362044 20

Infusomat Space Pump IV Administration Sets

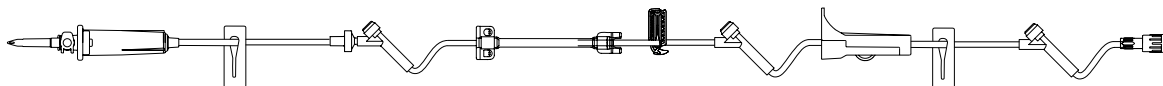

(15 drops/mL) Universal spike, slide clamp, pressure limited check valve, three SAFELINE injection sites 104 inches, 70 inches and 6 inches above distal end, free flow protection clamp, roller clamp, slide clamp, SPIN-LOCK connector. Components do not contain DEHP or natural rubber latex. Priming volume: 22 mL, Length: 120 in. (305 cm)

362032 362032 24

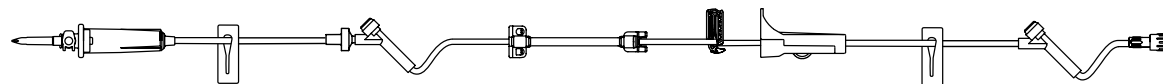

(15 drops/mL) Universal spike, slide clamp, pressure limited check valve, two SAFELINE injection sites 88 inches and 6 inches above distal end, free flow protection clamp, roller clamp, slide clamp, SPIN-LOCK connector. Components do not contain DEHP or natural rubber latex. Priming volume: 22 mL, Length: 120 in. (305 cm)

362036 362036 24

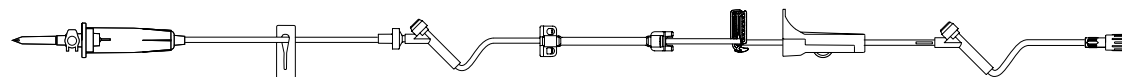

(60 drops/mL) Universal spike, slide clamp, pressure limited check valve, two SAFELINE injection sites 82 inches and 6 inches above distal end, free flow protection clamp, roller clamp, flow restrictor before distal injection site, SPIN-LOCK connector. Components do not contain DEHP or natural rubber latex. Priming volume: 21 mL, Length: 115 in. (292 cm)

362042 362042 24

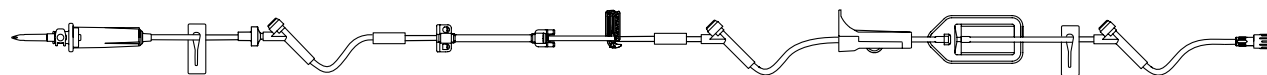

(15 drops/mL) Universal spike, slide clamp, pressure limited check valve, 3 SAFELINE injection sites, Supor® Membrane 0.2 micron air eliminating filter, roller clamp, SPIN-LOCK connector. Components do not contain DEHP or natural rubber latex. Priming volume: 26 mL, Length: 124 in. (315 cm)

362050 362050 24

Infusomat Space Pump Y-Type Blood Set

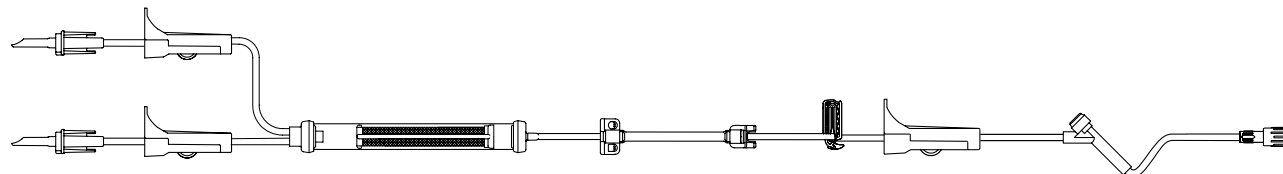



Two non-vented spikes, three roller clamps, 170 micron blood filter, free flow protection clamp, SAFELINE injection site 6 inches above distal end, SPIN-LOCK connector. Components do not contain natural rubber latex. Priming volume: 39 mL, Length: 120 in. (305 cm)

362043 362043 24

Infusion Systems

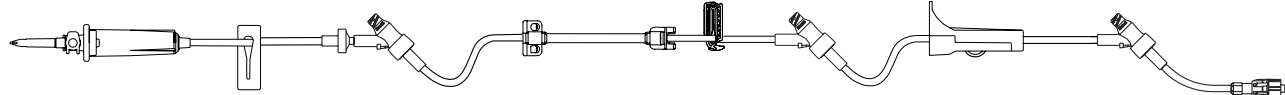
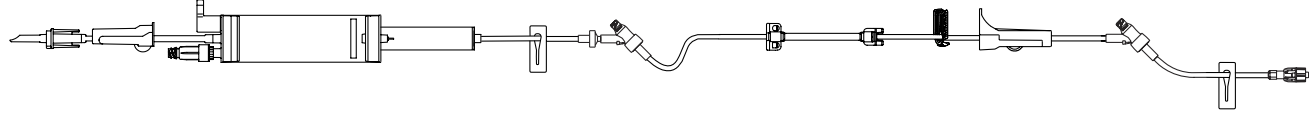
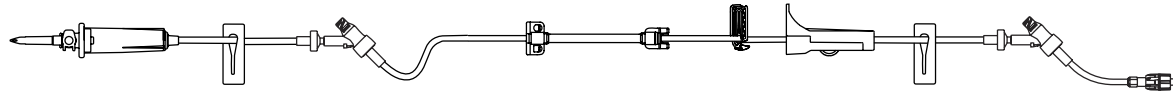
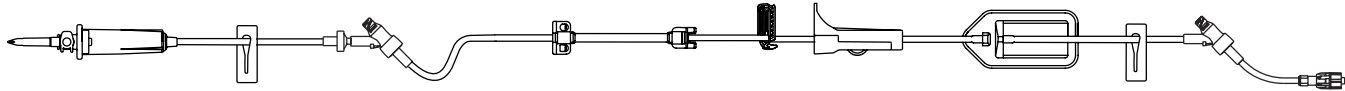
Infusomat® Space Pump Sets with CARESITE® Needleless IV System

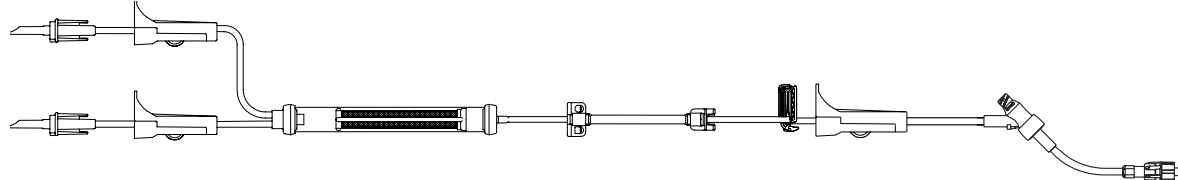
Description	Product Code	REF Number	Units Per cs
 <p>(15 drops/mL) Universal spike, slide clamp, pressure limited check valve, 3 CARESITE injection sites 104 inches, 70 inches, and 6 inches above distal end, free flow protection clamp, backcheck valve, roller clamp, slide clamp, SPIN-LOCK connector. Components do not contain DEHP or natural rubber latex. Priming volume: 22 mL, Length: 120 in. (305 cm)</p>	490100	490100	24
 <p>(60 drops/mL) Non-vented spike, roller clamp, 150 mL burette with 15 micron air guard filter and CARESITE injection site, slide clamp, pressure limited check valve, 2 CARESITE injection sites 71 inches and 6 inches above distal end, free flow protection clamp, roller clamp, flow restrictor, backcheck valve at distal Y-site, slide clamp, SPIN-LOCK connector. Components do not contain DEHP or natural rubber latex. Priming volume: 19 mL, Length: 120 in. (305 cm)</p>	490101	490101	20
 <p>(15 drops/mL) Universal spike, slide clamp, pressure limited check valve, 2 CARESITE injection sites 88 inches and 6 inches above distal end, free flow protection clamp, backcheck valve at distal Y-site, roller clamp, slide clamp, SPIN-LOCK connector. Components do not contain DEHP or natural rubber latex. Priming volume: 22 mL, Length: 120 in. (305 cm)</p>	490102	490102	24
 <p>(15 drops/mL) Universal spike, slide clamp, pressure limited check valve, 2 CARESITE injection sites 82 inches and 6 inches above distal end, free flow protection clamp, roller clamp, SUPOR® 0.2 micron air-eliminating filter, slide clamp, SPIN-LOCK connector. Components do not contain DEHP or natural rubber latex. Priming volume: 19 mL, Length: 120 in. (305 cm)</p>	490103	490103	24
 <p>(60 drops/mL) Universal spike, slide clamp, pressure limited check valve, 2 CARESITE injection sites 82 inches and 6 inches above distal end, free flow protection clamp, roller clamp, flow restrictor, backcheck valve at distal Y-site, SPIN-LOCK connector. Components do not contain DEHP or natural rubber latex. Priming volume: 21 mL, Length: 115 in. (292 cm)</p>	490104	490104	24
 <p>Two non-vented spikes, two roller clamps, 170 micron blood filter, free flow protection clamp, roller clamp, backcheck valve, CARESITE injection site 6 inches above distal end, SPIN-LOCK connector. Components do not contain natural rubber latex. Priming volume: 39 mL, Length: 120 in. (305 cm)</p>	490105	490105	24

Infusion Systems

Infusion Pump

Description	Product Code	REF Number	Qty.
-------------	--------------	------------	------

Vista® basic Infusion Pump



The Vista basic Infusion Pump combines high reliability and low disposable costs in an easy-to-use pump for clinicians and patients in the alternate site setting.

Vista basic Infusion Pump	637-202	637-202	1
---------------------------	---------	---------	---

Basic Set for Vista Pump

Components on the sets below do not contain DEHP or natural rubber latex.

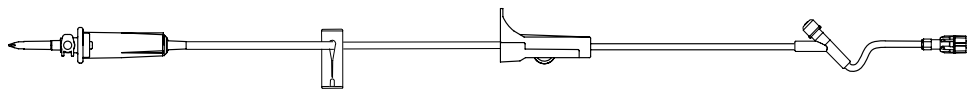

(15 drops/mL) Universal spike, slide clamp, roller clamp, injection site 6 in. above distal end, SPIN-LOCK® connector. Priming volume: 20 mL, Length: 113 in. (287 cm)	V8800	352229	50
--	-------	--------	----

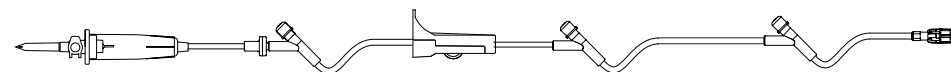

(60 Drops/mL) Universal spike, backcheck valve, injection sites 63, 28 and 6 inches above distal end, roller clamp, SPIN-LOCK connector. Priming Volume: 16 mL, Length: 87 in. (221 cm).	V1448	V1448	50
--	-------	-------	----

Filterflow® Filtered Set for Vista Pump

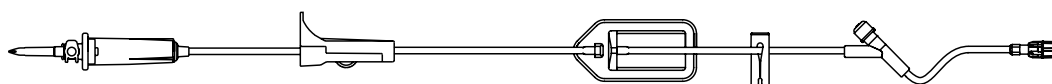

(15 drops/mL) Universal spike, roller clamp, 1.2 micron filter, slide clamp, injection site 6 in. above distal end, SPIN-LOCK connector. Priming volume: 19 mL, Length 106 in. (269 cm)	V8812F	352401	50
---	--------	--------	----

Basic Set for Vista Pump with ULTRASITE® Needleless Injection Site

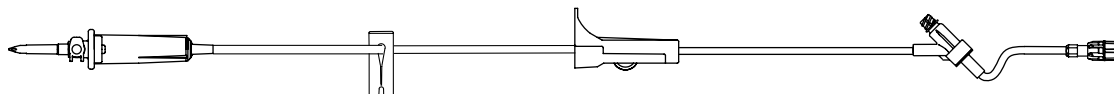

(15 drops/mL) Universal spike, integrated free-flow protector ¹ /slide clamp ² , roller clamp, ULTRASITE injection site 6 in. above distal end, SPIN-LOCK connector. Priming volume: 16.8 mL, Length: 113 in. (287 cm)	US8800	352337	50
--	--------	--------	----

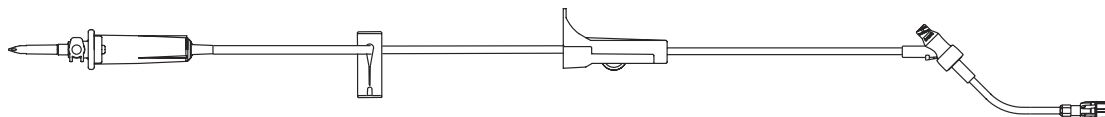

(15 drops/mL) Universal spike, integrated free-flow protector ¹ /slide clamp ² , roller clamp, ULTRASITE injection site 6 in. above distal end, SPIN-LOCK connector. Priming volume: 16.8 mL, Length: 113 in. (287 cm)	354201	354201	50
--	--------	--------	----

1. For Vista® Reliance Pump only
 2. For all other Vista basic and gravity applications

Vista® basic Pump and Gravity Administration Sets

Description	Product Code	REF Number	Units Per cs
-------------	--------------	------------	--------------

Filterflow® Filtered Sets for Vista Pump with ULTRASITE® Needleless Injection Sites

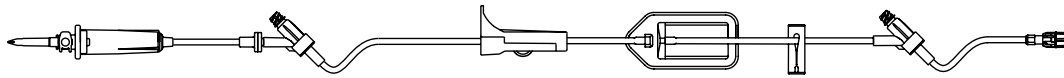

(15 drops/mL) Universal spike, backcheck valve, ULTRASITE injection sites 87 in. and 6 in. above distal end, roller clamp, 0.2 micron filter, slide clamp, SPIN-LOCK® connector. Components do not contain DEHP or natural rubber latex. Priming volume: 19 mL, Length: 104 in. (264 cm)

US8801F

352437

50

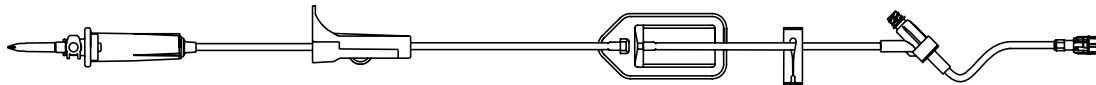

(15 drops/mL) Universal spike, roller clamp, 1.2 micron filter, slide clamp, ULTRASITE injection site 6 in. above distal end, and SPIN-LOCK connector. Components do not contain DEHP or natural rubber latex. Priming volume: 23 mL, Length 98 in. (249 cm)

US8812F

US8812F

50

Blood Set for Vista Pump with ULTRASITE Needleless Injection Site

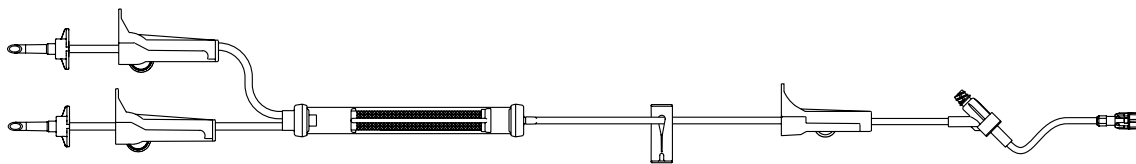

(10 drops/mL) Blood set, Y-type, non-vented spikes, two upper roller clamps, drip chamber with 170 micron blood filter, slide clamp, roller clamp, ULTRASITE injection site 6 in. above distal end, SPIN-LOCK connector. Components do not contain natural rubber latex. Priming volume: 31 mL, Length 110 in. (285 cm)

US8850

US8850

50

Vista® basic Pump Administration Sets

Components on this page do not contain DEHP or natural rubber latex.

Description	Product Code	REF Number	Units Per cs
-------------	--------------	------------	--------------

Free Flow Protection (FFP) Set for Vista Pump



(15 drops/mL) Universal spike, roller clamp, free flow protection (FFP) device 28 in. above distal end, SPIN-LOCK® connector. Priming volume: 21 mL, Length 108 in. (274 cm)

V9905 V9905 50

Free Flow Protection (FFP) Set for Vista Pump with 0.2 micron Filter

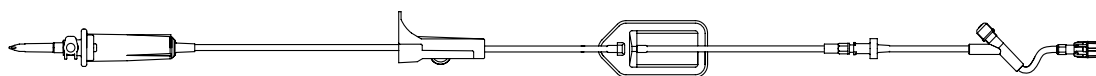

(15 drops/mL) Universal spike, roller clamp, 0.2 micron filter, free flow protection (FFP) device 28 in. above distal end, standard injection site 6 in. above distal end, SPIN-LOCK connector. Priming volume: 25 mL, Length: 118 in. (300 cm)

V9902F V9902F 50

Free Flow Protection (FFP) Set for Vista Pump with 1.2 micron Filter

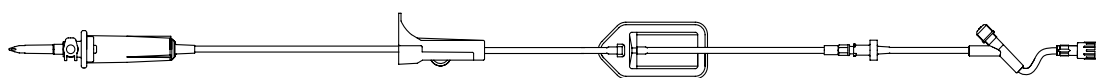

(15 drops/mL) Universal spike, roller clamp, 1.2 micron filter, free flow protection (FFP) device 28 in. above distal end, standard injection site 6 in. above distal end, SPIN-LOCK connector. Priming volume: 26 mL, Length: 117 in. (287cm)

V9912F 352456 50

Free Flow Protection (FFP) Set for Vista Pump with ULTRASITE® Needleless Injection Site

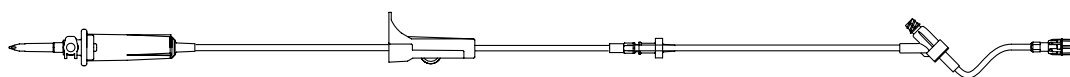

(15 drops/mL) Universal spike, roller clamp, free flow protection (FFP) device 28 in. above distal end, ULTRASITE injection site 6 in. above distal end, SPIN-LOCK connector. Priming volume: 20 mL, Length: 104 in. (264 cm)

US9900 352419 50

Free Flow Protection (FFP) Set for Vista Pump with ULTRASITE Needleless Injection Sites and 0.2 micron Filter

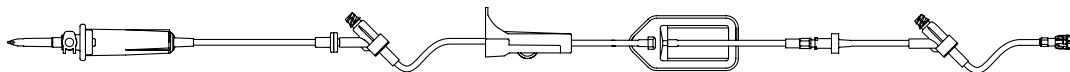

(15 drops/mL) Universal spike, 2 backcheck valves, ULTRASITE injection sites 80 in. and 6 in. above distal end, roller clamp, 0.2 micron filter, free flow protection (FFP) device 28 in. above distal end, SPIN-LOCK connector. Priming volume: 26 mL, Length: 121 in. (307 cm)

US9922F US9922F 50

BodyGuard® Infusion Pumps

Product code

BodyGuard 323 Infusion Pump Kit: Standard Battery and Pole-Mount Charger

100-510PXS



Kit includes:

- BodyGuard 323 Infusion Pump
- Rechargeable Li-Polymer Standard Battery, 1800mAh
- Pole-Mount Charger
- Operator's Manual

- Dimensions: 4.5 X 3.5 X 1.6 inches (112 X 89 x 40 mm) (H/W/D)
- Weight: 13.8 oz (390 g) with standard battery

BodyGuard 323 Infusion Pump Kit: Standard Battery and AC Wall Charger

100-517PXS



Kit includes:

- BodyGuard 323 Multi-therapy Infusion Pump
- Rechargeable Li-Polymer Standard Battery, 1800mAh
- AC Wall Charger/Power Adaptor
- Operator's Manual

- Dimensions: 4.5 X 3.5 X 1.6 inches (112 X 89 X 40 mm) (H/W/D)
- Weight: 13.8 oz (390g) with standard battery

BodyGuard 323 Infusion Pump Kit: Extended Battery and AC Wall Charger

100-516PXS



Kit includes:

- BodyGuard 323 Multi-therapy Infusion Pump
- Rechargeable Li-Polymer "Extended Life" Battery, 3600mAh
- AC Wall Charger/Power Adaptor
- Operator's Manual

- Dimensions: 4.5 X 3.5 X 1.6 inches (112 X 89 X 40 mm) (H/W/D)
- Weight: 13.8 oz (390g) with standard battery

BodyGuard 323 Infusion Pump Kit: Extended Battery and Tabletop Charger

100-518PXS



Kit includes:

- BodyGuard 323 Multi-therapy Infusion Pump
- Two Rechargeable Li-Polymer "Extended Life" Batteries, 3600mAh
- Tabletop Charger
- Standard Power Cord
- Operator's Manual

- Dimensions: 4.5 X 3.5 X 1.6 inches (112 X 89 X 40 mm) (H/W/D)
- Weight: 13.8 oz (390g) with standard battery

To order, call 1-800-227-2862

BodyGuard Infusion Pumps (cont.)

Product code

BodyGuard 545 Infusion Pump Kit

100-919PXIS



Kit includes:

- Epidural infusion pump
 - Rechargeable Li-Polymer Battery, Power Cord and Pole Mount Charger
 - Ambulatory and pole mounted
 - Optional pulse oximeter capability
-
- Dimensions: 4.5 X 3.5 X 1.6 inches (112 x 89 x 40 mm) (H/W/D)
 - Weight: 13.8 oz (390 g) with standard battery

BodyGuard 575 Infusion Pump Kit

100-729PXS



Kit includes:

- Pain management infusion pump
 - Rechargeable Li-Polymer Battery, Power Cord and Pole Mount Charger
 - Pre-program up to 26 drug protocols
 - Ambulatory and pole-mounted
 - Optional PCA Bolus Button Cable
-
- Dimensions: 4.5 X 3.5 X 1.6 inches (112 x 89 x 40 mm) (H/W/D)
 - Weight: 13.8 oz (390 g) with standard battery

BodyGuard 121 Infusion Pump Kit

100-908PTS



Kit includes:

- Dual channel infusion pump
 - Pole Mount Charger and Power Cord
 - Ambulatory and pole mounted
 - Optional drop sensor for each channel
-
- Dimensions: 5.7 X 3.3 X 1.6 inches (146 x 84 x 40 mm) (H/W/D)
 - Weight: 15.9 oz (450 g) with internal battery

To order, call 1-800-227-2862

Chargers, Batteries, Cables and Cords

Product code

Pole-Mount Charger

150-314XUP



- Fits the BodyGuard 323 pump
- Bright screen displays pump messages and delivery values
- Release button allows quick removal for ambulatory applications

Pole-Mount Charger with RS 232 Cable and Power Cord

150-318XP

Tabletop Charger

150-331XP



- Recharges Standard and "Extended Life" Li-Polymer Batteries
- Connects to wall (AC) outlet using Standard Power Cord
- Battery recharge time approximately 6 to 8 hours

Wall Charger

150-336XP



- Connects pump to wall (AC) power
- Connector plugs into pump DC Port
- Trickle-charges battery while providing pump power

Disposable Battery Pack, 9V

130-050X2P



- Holds two (2) 9-volt alkaline batteries
- Provides 8 to 10 hours of pump operation at infusion rate of 125 mL/hr
- Alternative to using Rechargeable Li-Polymer Battery

Rechargeable Li-Polymer Battery, 1800 mAh

130-050XAP



- Standard battery supplied with BodyGuard 323 pump
- Provides 16 to 18 hours operating time at 125 mL/hr; 36 hours at 5 mL/hr

To order, call 1-800-227-2862

Chargers, Batteries, Cables and Cords (cont.)

Product code

Rechargeable Li-Polymer Battery, 3600 mAh

130-051XP



- Recharges Standard and "Extended Life" Li-Polymer Batteries
- Connects to wall (AC) outlet using Standard Power Cord
- Battery recharge time approximately 6 to 8 hours

Bolus Button Cable

140-000XP



- Cable 140-000XP
- Provides additional means for administering PCA bolus doses
- Connects to pump Bolus Jack

DC Cable

196-000XP



- For charging pump when in Lock Box
- Connects from pump DC Port to Pole-Mount Charger or Tabletop Charger

Hospital Power Cord

CL60106P

RS 232 Cable

SDC-01P

Standard Power Cord

SPC-01P



- Connects Pole-Mount Charger or Tabletop Charger to wall (AC) outlet
- 3 prong plug-in / 3 prong outlet

To order, call 1-800-227-2862

BodyComm® Pump Communication System

Product code

BodyComm System Kit

CommBG323P



Kit includes:

- BodyComm Software
- Pole-Mount Charger
- Serial RS 232 Cable
- AC Power Cord
- Instruction Sheet
- Computer not included

Computer System Requirements:

- PC running Microsoft Windows XP® or Windows Vista®
- Serial Port
- Optional: Microsoft Excel® to save data as Excel files

Features:

- Download a record of up to 500 pump events, including alarms and keypad actions taken by user
- Download hour-by-hour history views of normal pump operation
- Select and save desired device settings (infusion mode, flow rate, maximum pressure, etc) as a template to program multiple pumps identically

Lock Boxes and Other Accessories

500 mL Lock Box

190-000XCP



- Pole-mountable
- Holds up to 500 mL reservoir bag
- Compatible with all brands of collapsible reservoir bags (right-angled spike set available for longer bags)
- Two locks: one for pump/bag access, second to lock box onto IV pole
- Can be placed on bed stand; has handle for carrying
- Exit ports for power cord, bolus button cable, tubing set



Lock Box Replacement Keys (Set of 3)

190-115XP

BodyGuard 323 Infusion Pump Operator's Manual

To order, call 1-800-227-2862

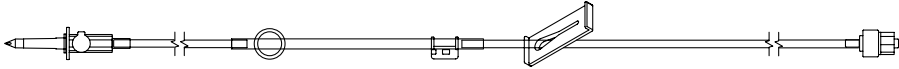
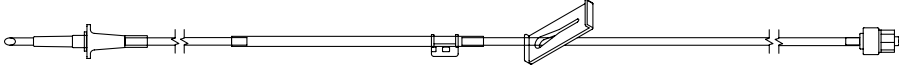
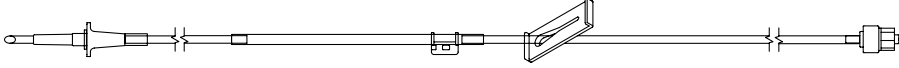
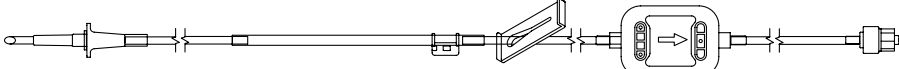
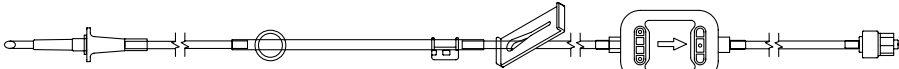
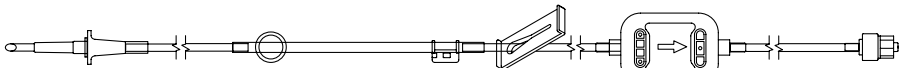
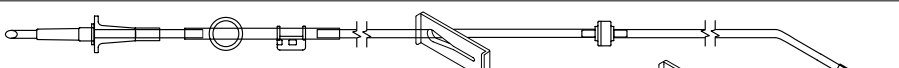
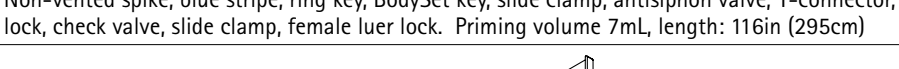
BodyGuard® Pump Administration Sets

Description	Product Code	Units per Case
Recommended for use with the CME BodyGuard® ColorVision™ 575 PCA and CME BodyGuard 323 Pumps (Microbore)		
 Vented spike, blue stripe, ring key, Bodysset key, slide clamp, male luer lock/antisyphon valve. Priming volume: 7mL, length: 130in (330cm)	A120-161XPSV	20
 Non-vented spike, blue stripe, Bodysset key, slide clamp, male luer lock/antisyphon valve. Priming volume: 4mL, length: 83in (210cm)	A120-160XPS	20
 Non-vented spike, blue stripe, Bodysset key, slide clamp, male luer lock/antisyphon valve. Priming volume: 6mL, length: 110in (280cm)	A120-161XPS	20
 Non-vented spike, blue stripe, Bodysset key, slide clamp, 0.2 micron filter, male luer lock/antisyphon valve. Priming volume: 9mL, length: 134in (340cm)	A120-160XSFE	16
 Non-vented spike, blue stripe, ring key, Bodysset key, slide clamp, 1.2 micron filter, male luer lock/ antisyphon valve. Priming volume: 8mL, length: 110in (280cm)	A120-112XSFK	16
 Non-vented spike, blue stripe, ring key, Bodysset key, slide clamp, 0.2 micron filter, male luer lock/ antisyphon valve. Priming volume: 8mL, length: 110in (280cm)	A120-160XSFK	16
 Non-vented spike, blue stripe, ring key, BodySet key, slide clamp, antisyphon valve, Y-connector, male luer lock, check valve, slide clamp, female luer lock. Priming volume 7mL, length: 116in (295cm)	A120-161XYBS	16
 Female luer lock, blue stripe, Bodysset key, slide clamp, male luer lock/antisyphon valve. Priming volume: 1mL, length: 12in (30cm)	A120-160XPSN	20
 Male Luer lock, blue stripe, ring key, Bodysset key, slide clamp, 0.2 micron filter, antisyphon valve, Y-connector, female luer lock, check valve, slide clamp, male luer lock. Priming volume: 8mL, length: 130in (330cm)	A120-160XYBF	16

Infusion Systems

To order, call 1-800-227-2862

BodyGuard® Pump Administration Sets

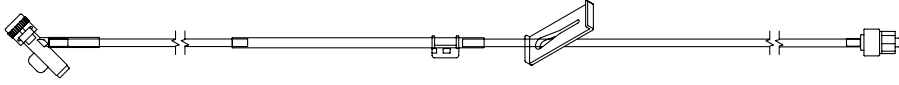
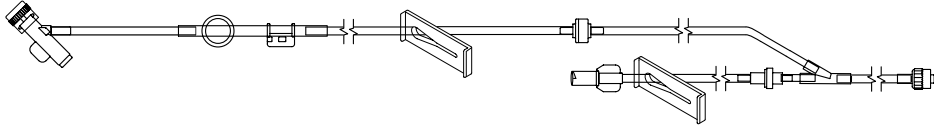
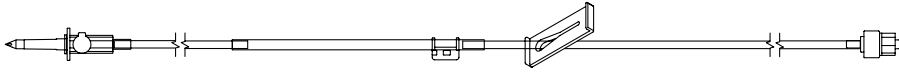
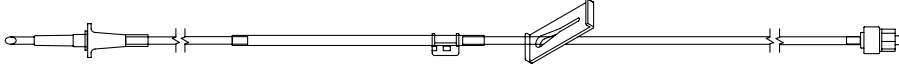
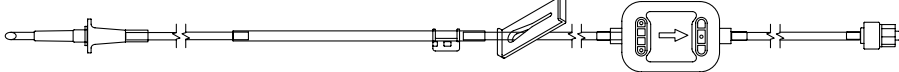
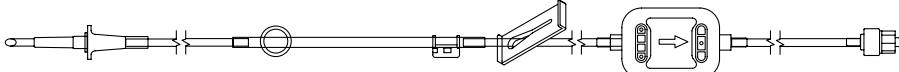
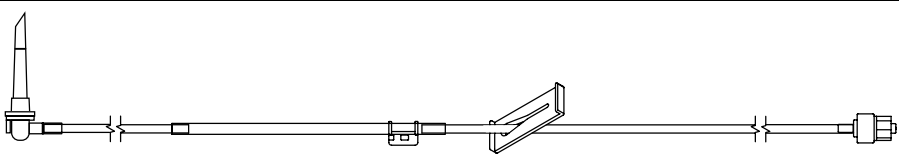
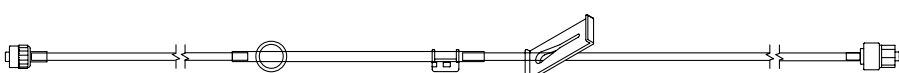
Description	Product Code	Units per Case
 <p>Syringe adapter, blue stripe, Bodyset key, slide clamp, male luer lock/antisiphon valve. Priming volume: 5mL, length: 103in (260cm)</p>	A100-163XSL	20
 <p>Syringe adapter, blue stripe, ring key, BodySet key, slide clamp, antisiphon valve, Y-connector, male luer lock, check valve, slide clamp, female luer lock. Priming volume: 7mL, length: 115in (290cm)</p>	A120-161XYB	16
<p>Recommended for use with the CME BodyGuard® ColorVision™ 545 Epidural and CME BodyGuard 323 Pumps (Microbore)</p>		
 <p>Vented spike, yellow stripe, Bodyset key, slide clamp, male luer lock/antisiphon valve. Priming volume: 5mL, length: 94in (240cm)</p>	A100-163XESV	20
 <p>Non-vented spike, yellow stripe, Bodyset key, slide clamp, male luer lock/antisiphon valve. Priming volume: 5mL, length: 94in (240cm)</p>	A100-163XES	20
 <p>Non-vented spike, yellow stripe, Bodyset key, slide clamp, 0.2 micron filter, male luer lock/antisiphon valve. Priming volume: 7mL, length: 85in (220cm)</p>	A100-163XESF	20
 <p>Non-vented spike, yellow stripe, ring key, Bodyset key, slide clamp, 0.2 micron filter, male luer lock/antisiphon valve. Priming volume: 8mL, length: 105in (270cm)</p>	A100-164XESF	16
 <p>90 Degree Spike, yellow stripe, Bodyset key, slide clamp, male luer lock/antisiphon valve. Priming volume: 5mL, length: 90in (230cm)</p>	A100-163XE90S	20
 <p>Male Luer Lock, yellow stripe, ring key, Bodyset key, slide clamp, male luer lock/antisiphon valve. Priming volume: 8mL, length: 130in (330cm)</p>	A100-163XE90S	20

Infusion Systems

BodyGuard® Pump Administration Sets

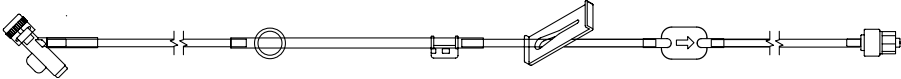
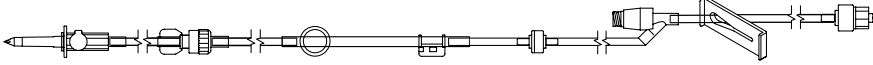
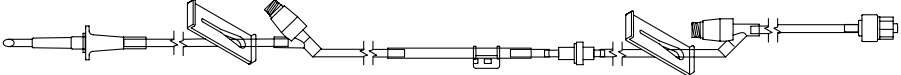
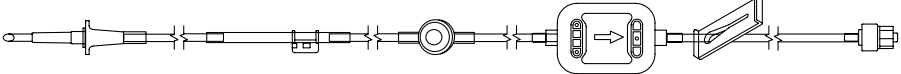
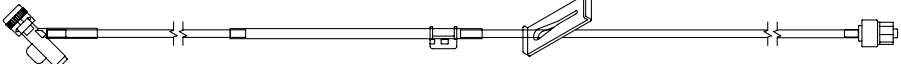
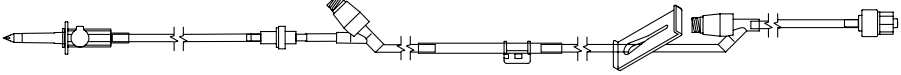
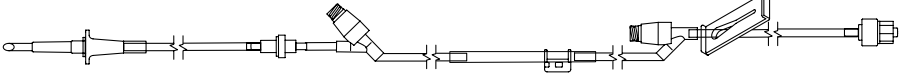
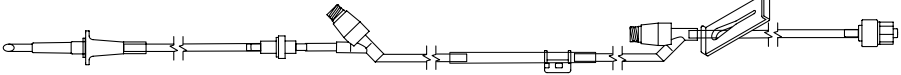
Description	Product Code	Units per Case
 <p>Syringe adapter, yellow stripe, ring key, Bodysset key, slide clamp, 0.2 micron filter, male luer lock/antisiphon valve. Priming volume: 7mL, Length: 110in (280cm)</p>	A100-163XSFL	16
Recommended for use with the CME BodyGuard® 323 Pump (Microbore)		
 <p>Vented spike, female luer lock, male luer lock, ring key, Bodysset Key, antisiphon valve, needleless Y-site, slide clamp, male luer lock. Priming volume 8mL, length: 150in (380cm)</p>	A120-003XYV	12
 <p>Non-vented spike, slide clamp, needleless Y-site, Bodysset key, antisiphon valve, slide clamp, needleless Y-site, male luer lock. Priming volume: 3.7mL, length: 63in (159cm)</p>	A120-160X2YB	20
 <p>Non-vented spike, Bodysset key, manual priming valve, 1.2 micron filter, slide clamp, male luer lock/antisiphon valve. Priming volume: 8mL, length: 110in (280cm)</p>	A120-112XSfV	16
 <p>Syringe adapter, Bodysset key, slide clamp, male luer lock/antisiphon valve. Priming volume: 1mL length: 11in (28cm)</p>	A100-163XS	20
Recommended for use with the CME BodyGuard 323 and CME BodyGuard 121 Pumps (Microbore)		
 <p>Vented spike, check valve, needleless Y-site, Bodysset key, slide clamp, needleless Y-site, male luer lock/antisiphon valve. Priming volume: 20mL, Length: 115in (290cm)</p>	A120-003XS2YV	12
 <p>Non-vented spike, check valve, needleless Y-site, Bodysset key, needleless Y-site, slide clamp, male luer lock/antisiphon valve. Priming volume: 20mL, length: 115in (290cm)</p>	A120-125XS	16
 <p>Non-vented spike, check valve, needleless Y-site, Bodysset key, needleless Y-site, slide clamp, male luer lock/antisiphon valve. Priming volume: 22mL, length: 128in (320cm)</p>	A120-125XSE	16

BodyGuard® Pump Administration Sets

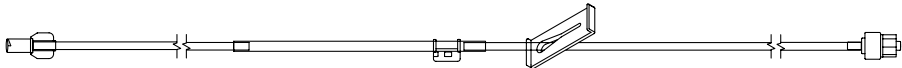
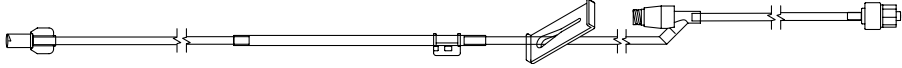
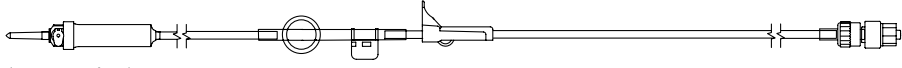
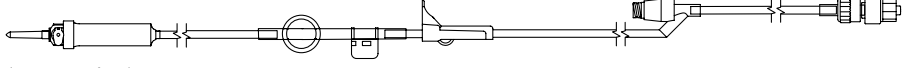
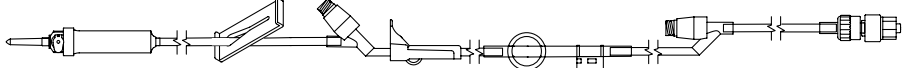
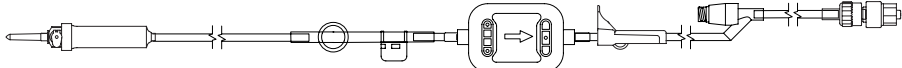
Description	Product Code	Units per Case
 <p>Female luer lock, Bodysset key, slide clamp, male luer lock/antisiphon valve. Priming volume: 15mL, length: 83in (210cm)</p>	A120-003XSN	20
 <p>Female luer lock, Bodysset key, slide clamp, needleless Y-site, male luer lock/antisiphon valve. Priming volume: 15mL, length: 83in (210cm)</p>	A120-003XSNY	20
<p>Recommended for use with the CMExpress® Pump</p>		
 <p>(20 drops/mL) Drip chamber, ring key, CMExpress key, roller clamp, male luer lock, removable male luer lock/antisiphon valve. Priming volume: 7mL, length: 80in (200cm)</p>	A120-160CRV	16
 <p>(20 drops/mL) Drip chamber, ring key, CMExpress key, roller clamp, needleless Y-site, male luer lock, removable male luer lock/antisiphon valve. Priming volume: 7mL, length: 80in (200cm)</p>	A120-160CYRV	16
 <p>(20 drops/mL) Drip chamber, slide clamp, needleless Y-site, roller clamp, ring key, CMExpress key, needleless Y-site, male luer lock, removable male luer lock/antisiphon valve. Priming volume: 8mL, length: 95in (240cm)</p>	A120-160C2YRV	16
 <p>(20 drops/mL) Drip chamber, ring key, CMExpress key, 0.2 micron filter, roller clamp, needleless Y-site, male luer lock, removable male luer lock/antisiphon valve. Priming volume: 9mL, length: 80in (200cm)</p>	A120-160CYFRV	16

Syringe Pump Sets

Components on this page do not contain natural rubber latex.

Description	Product Code	REF Number	Units Per cs
-------------	--------------	------------	--------------

Syringe Pump Fluid Path Microbore Extension Sets – Polyethylene lined

Components do not contain DEHP

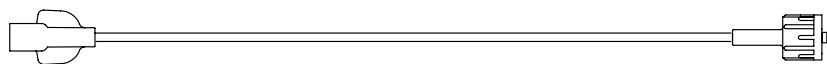

Female luer and distal male luer lock. Microbore extension set, 0.02 in. ID. with fluid path that does not contain PVC. Priming volume: 0.3 mL, Length: 36 in. (91 cm)

V6220

V6220

50

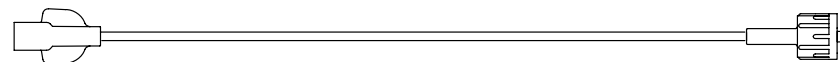

Female luer and distal male luer lock. Microbore extension set, 0.03 in. ID. with fluid path that does not contain PVC. Use with higher flow rates and viscous fluids. Priming volume: 0.6 mL, Length: 36 in. (91 cm)

V6203

V6203

50

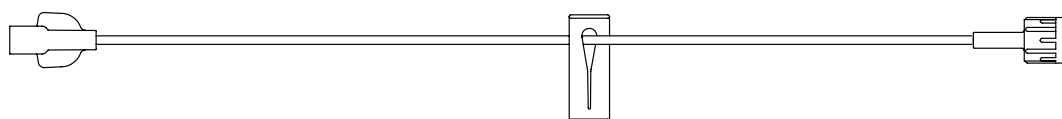

Female luer and distal male luer lock, slide clamp. Microbore extension set, 0.02 in. ID. with fluid path that does not contain PVC. Priming volume: 0.5 mL, Length: 60 in. (152 cm)

V6222

V6222

50

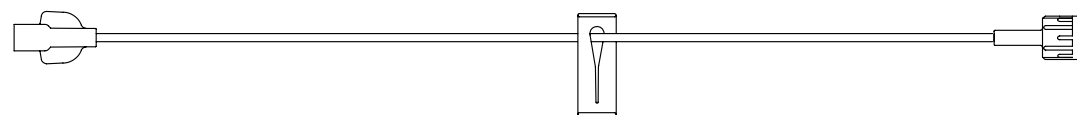

Female luer and distal male luer lock, slide clamp. Microbore extension set, 0.03 in. ID. with fluid path that contains no PVC. Use with higher flow rates and viscous fluids. Priming volume: 0.8 mL, Length: 60 in. (152 cm)

V6223

V6223

50



Female luer and distal male luer lock. Microbore extension set, 0.03 in. ID. with fluid that contains no PVC, 0.2 micron filter. Priming volume: 1.3 mL, Length: 60 in. (152 cm)

V6215

V6215

50

Syringe Pump Microbore Extension Sets with Proximal and Distal Male Luer Locks

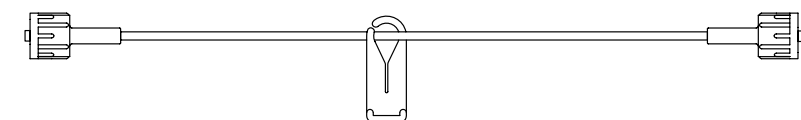

Proximal and distal male luer locks. Microbore extension set, 0.04 in. ID., slide clamp. Priming volume: 0.6 mL, Length: 31 in. (79 cm)

V5450

V5450

50

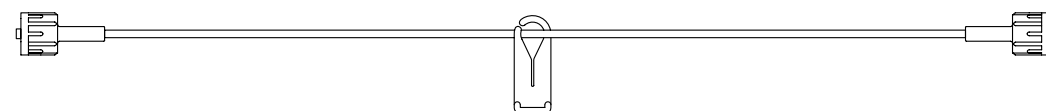

Proximal and distal male luer locks. Microbore extension set, 0.04 in. ID., slide clamp. Priming volume: 1.2 mL, Length: 63 in. (160 cm)

V5456

V5456

50

IV Poles and Stands

Description	Product Code	REF Number	Units Per cs
Custom IV stand, four legs with heavy duty casters and piggyback hook	N7514	N7514	1
Custom Patient Pal® IV Stand with patient hand grip, heavy duty casters, oxygen cylinder platform, piggyback hook, four legs	N7515	N7515	1
Custom IV stand, six legs with heavy duty casters and piggyback hook	N7516	N7516	1
Custom multi-device stand for Outlook® Pump, six legs with heavy duty casters and piggyback hooks	N7617	N7617	1
Custom IV multi-device stand with attachment designed to hold 4 devices, six legs with heavy duty casters, 4 plug adapter, oxygen cylinder platform and piggyback hook	N7517	N7517	1
Custom utility IV stand with five legs	N7518	N7518	1
SAF-T-POLE™ irrigation tower, for Arthroscopic, TUR and other surgeries with large fluid requirements	N7560	N7560	1
Trans-Pal® IV stand with six legs. Features include pole connection to patient bed, support wheel with tray and 2 telescoping stainless steel poles with rake top	N7533	N7533	1
Versa Pole® telescoping stainless steel IV pole with 2 stainless steel hooks. Attaches to bed headboard or guerne during transport. Pole is 24" fully extended and features slow descending inner pole	N7534	N7534	1
Walk 'N' Roller® IV pole for homecare. Pole unfolds from a compact, highly portable position with no assembly required. Pole features easy rolling wheels and support handle for enhanced patient stability. Available with oxygen tank holder.	N7535	N7535	1
Custom IV multi device stand, six legs, modified Omni-Pal™ stand (not pictured).	N7717	N7717	1
Custom IV multi device stand, six legs, support wheel, utility tray and oxygen ring holder	N7514	N7514	1
Custom IV multi stand for Space Infusion Pumps, support handle, rake top, six legs	N7537	N7537	1

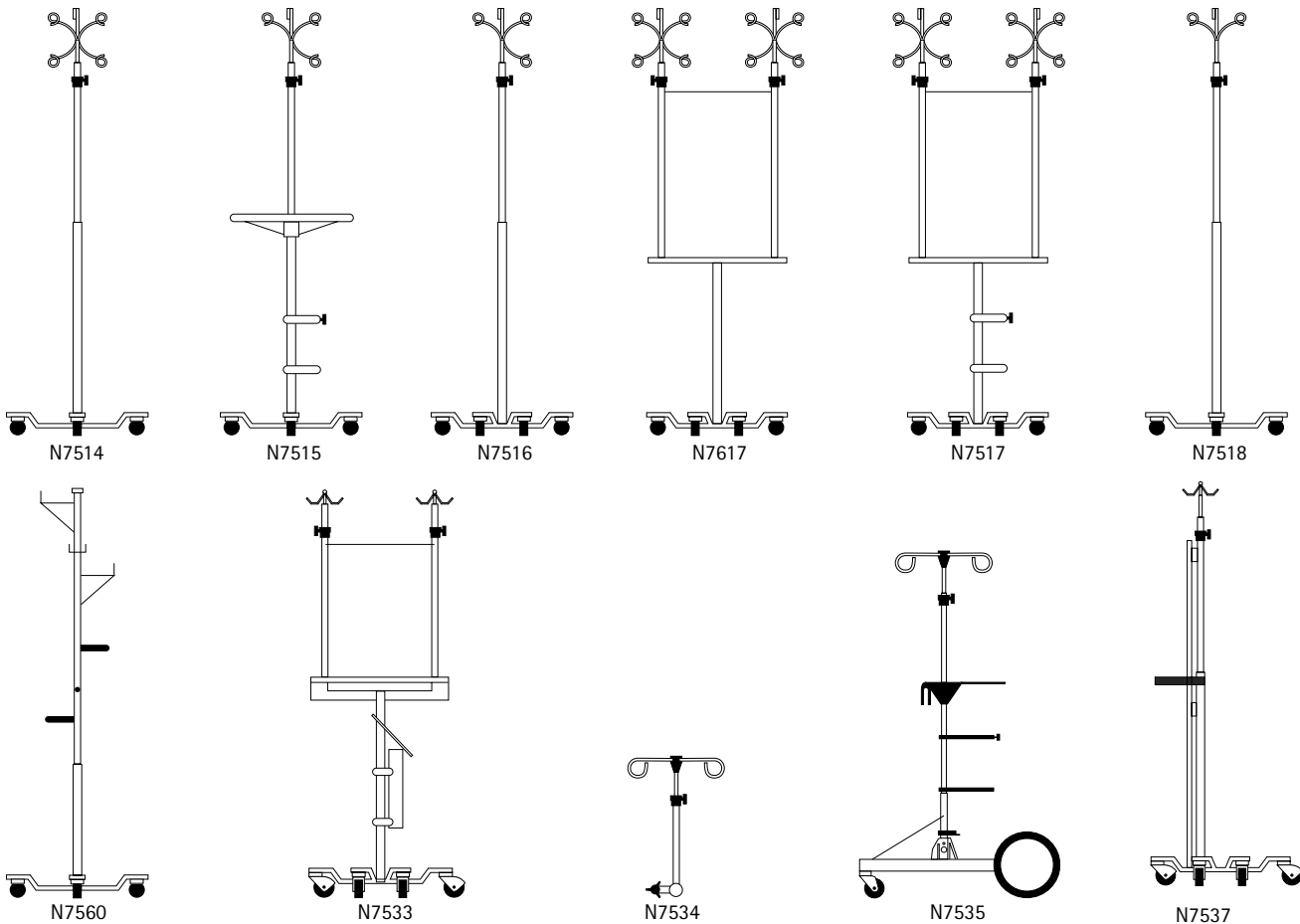

Infusion Systems

SAF-T-POLE is a trademark of American Medical Manufacturing, Inc.
 Omni-Pal is a trademark and Patient Pal, Trans-Pal, Versa Pole and Walk 'N' Roller are registered trademarks of Pryor Products, Inc.

ANESTHESIA IV PRODUCTS

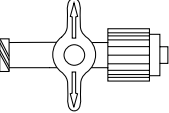
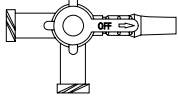
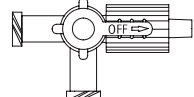
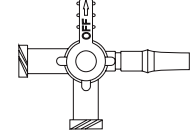
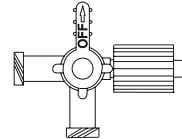
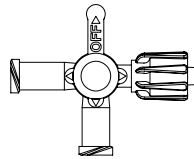
Description	Product Code	REF Number	Units Per cs
DISCOFIX® Stopcocks			
Components on this page do not contain DEHP or natural rubber latex.			
	D100	455980	100
<p>One-way stopcock with female luer lock port and SPIN-LOCK® connector, port covers. Lipid-resistant. Priming volume: 0.20 mL</p>			
	D201	455991	100
<p>Three-way stopcock with two female luer lock ports and male luer slip connector, port covers. Lipid-resistant. Priming volume: 0.26 mL</p>			
	D300	456003	100
<p>Three-way stopcock with two female luer lock ports and one SPIN-LOCK connector, port covers. Lipid-resistant. Priming volume: 0.26 mL</p>			
	D401	456006	100
<p>Four-way stopcock, two female luer lock ports and male luer slip connector, port covers. Lipid-resistant. Priming volume: 0.26 mL</p>			
	D500	456020	100
<p>Four-way stopcock, two female luer lock ports and SPIN-LOCK connector, port covers. Lipid-resistant. Priming volume: 0.26 mL</p>			
	D600	456060	100
<p>High-Flow, four-way stopcock, two female luer lock ports and SPIN-LOCK connector, port covers. . Lipid-resistant. Priming volume: 0.32 mL</p>			

Description	Product Code	REF Number	Units Per cs
-------------	--------------	------------	--------------

Ganged Stopcocks and Manifolds

Components on this page do not contain DEHP or natural rubber latex.

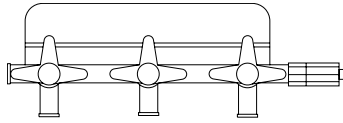

Three four-way stopcocks, four luer lock female ports and SPIN-LOCK® connector, port covers. Lipid-resistant. Priming volume: 0.82 mL. Length: 5 in. (12.7 cm)

D3500 455995 50

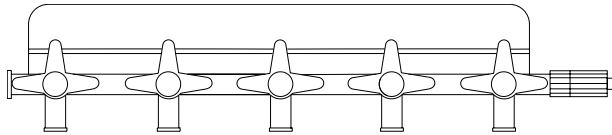

Five four-way stopcocks, six luer lock female ports and SPIN-LOCK connector, port covers. Lipid-resistant. Lipid-resistant. Priming volume: 1.43 mL. Length: 8 in. (20.3 cm)

MA5000M 513552 50

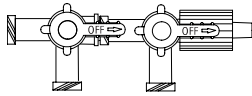

Two-gang, three-way stopcocks with three female luer lock ports and SPIN-LOCK connector, port covers. Lipid-resistant. Priming volume: 0.68 mL. Length: 3 in. (7.6 cm)

D201T 455992 100

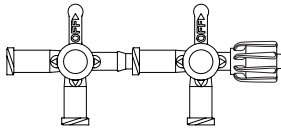

High flow, two-gang, four-way stopcocks, with three female luer lock ports and SPIN-LOCK connector, port covers. Lipid-resistant. Priming volume: 0.65 mL. Length: 3 in. (7.6 cm)

D602HF 456201 25

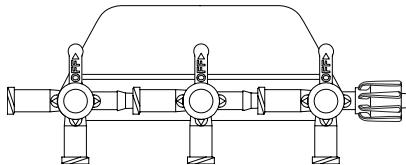

High Flow, three-gang, four-way stopcocks, with four female luer lock ports and SPIN-LOCK connector, port covers. Lipid-resistant. Priming volume: 0.95 mL. Length: 4 in. (10.2 cm)

D603HF 456301 25

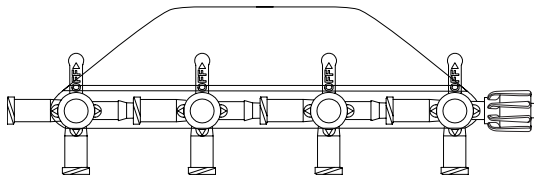

High-Flow, four-gang, four-way stopcocks, with five female luer lock ports and SPIN-LOCK connector, port covers. Lipid-resistant. Priming volume: 1.31 mL. Length: 5 in. (12.7 cm)

D604HF 456401 25

Anesthesia IV Sets

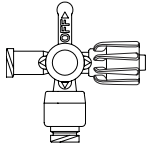
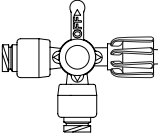
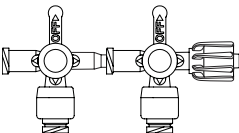
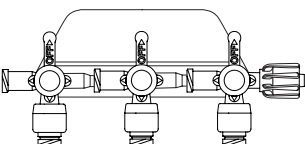
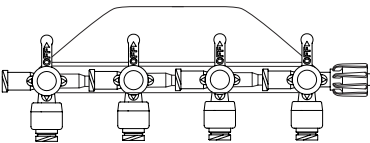
Description	REF Number	Units Per cs
ULTRAPORT™ and ULTRAPORT zero Luer-Activated Needleless Stopcocks		
	456501	100
<p>High-Flow, four-way stopcock with luer-activated ULTRAPORT port, female luer lock port and SPIN-LOCK® connector. Lipid-resistant. Does not contain DEHP or natural rubber latex. Priming volume: 0.17 mL</p>		
<p>ULTRAPORT zero version of the above stopcock - zero dead space in the stopcock.</p>	457501	100
	456502	100
<p>High-Flow, four-way stopcock with two luer-activated ULTRAPORT ports, and SPIN-LOCK connector. Lipid-resistant. Does not contain DEHP or natural rubber latex. Priming volume: 0.17 mL</p>		
<p>ULTRAPORT zero version of the above stopcock - zero dead space in the stopcock.</p>	457502	100
	456202	25
<p>Two-gang, high-flow, four-way stopcocks with two luer-activated ULTRAPORT ports, female luer lock port, and SPIN-LOCK connector. Lipid-resistant. Does not contain DEHP or natural rubber latex.</p>		
<p>Single sideport priming volume: 0.1 mL. Manifold priming volume: 0.8 mL</p>		
<p>ULTRAPORT zero version of the above stopcock - zero dead space in the stopcock.</p>	457202	25
	456302	25
<p>Three-gang, high-flow, four-way stopcocks with three luer-activated ULTRAPORT ports, female luer lock port, and SPIN-LOCK connector. Lipid-resistant. Does not contain DEHP or natural rubber latex.</p>		
<p>Single sideport priming volume: 0.1 mL. Manifold priming volume: 1.3 mL</p>		
<p>ULTRAPORT zero version of the above stopcock - zero dead space in the stopcock.</p>	457302	25
	456402	25
<p>Four-gang, high-flow, four-way stopcocks with four luer-activated ULTRAPORT ports, female luer lock port, and SPIN-LOCK connector. Lipid-resistant. Does not contain DEHP or natural rubber latex.</p>		
<p>Single sideport priming volume: 0.1 mL. Manifold priming volume: 1.7 mL</p>		
<p>ULTRAPORT zero version of the above stopcock - zero dead space in the stopcock.</p>	457402	25

Description	Product Code	REF Number	Units Per cs
-------------	--------------	------------	--------------

Open Lumen SAFEPORT™ Sets

Components listed below do not contain DEHP or natural rubber latex.

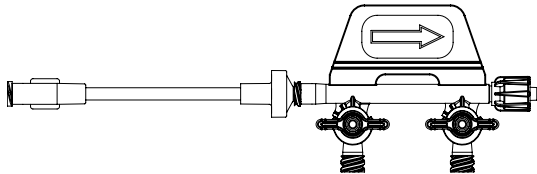

Dual port SAFEPORT with in-line backcheck valve and SPIN-LOCK connector.
Approximate priming volume: 1.4 mL Approximate length: 7 in. (17.7 in.)

456520 50

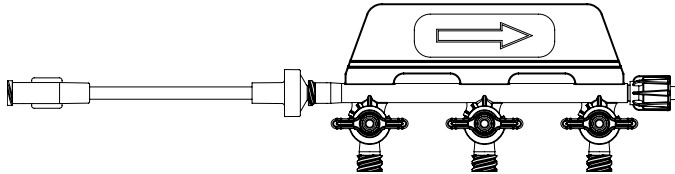

Triple port SAFEPORT with in-line backcheck valve and SPIN-LOCK connector.
Approximate priming volume: 1.7 mL Approximate length: 8 in. (20.3 in.)

456522 50

Swabbable Closed System SAFEPORT Sets

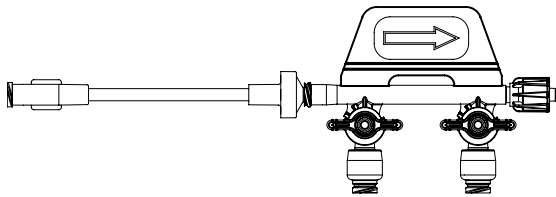

Dual swabbable port SAFEPORT with in-line backcheck valve and SPIN-LOCK connector.
Approximate priming volume: 1.4 mL Approximate length: 7 in. (17.7 in.)

456526 50

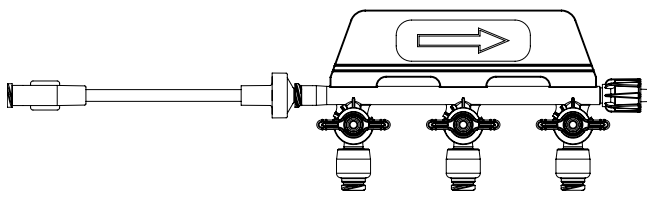

Triple swabbable port SAFEPORT with in-line backcheck valve and SPIN-LOCK connector.
Approximate priming volume: 1.9 mL Approximate length: 8 in. (20.3 in.)

456521 50

* For injection only

ANESTHESIA IV PRODUCTS

Description	Product Code	REF Number	Units Per cs
-------------	--------------	------------	--------------

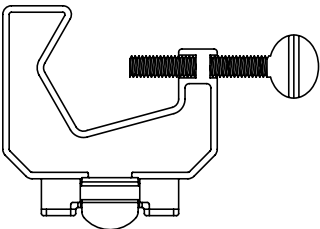

Manifold Pole Clamp – holds one normally closed low profile manifold in a fixed position on an IV pole. Reusable.

MPC1000 456100 1

Anesthesia Accessories

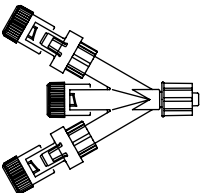

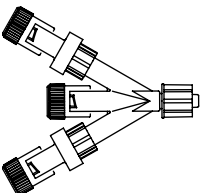

Tri-Connector with SAFSITE® Valves – two SAFSITE valves on tri-connector with SPIN-LOCK connector. Priming volume: 1.2 mL.

AET300 472025 50



Tri-Connector with Normally Closed Valves – two normally closed valves* on tri-connector with SPIN-LOCK connector. Priming volume: 1.2 mL.

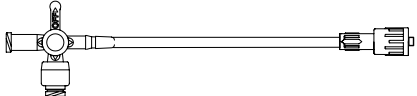
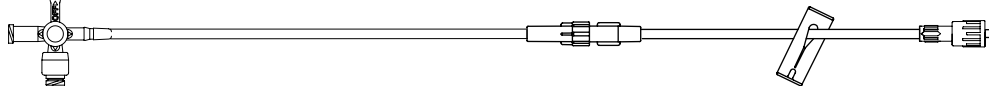
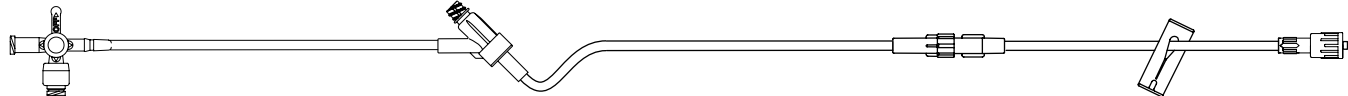

AET200 472026 50

Description	REF Number	Units Per cs
ULTRAPORT™ Luer-Activated Needleless Stopcock Extension Sets		
Components on this page do not contain DEHP or natural rubber latex.		
		
High-Flow, four-way stopcock with luer-activated ULTRAPORT port and female luer lock port, 8 in. (20.3 cm) extension tubing and SPIN-LOCK® connector. Priming volume: 1.5 mL. Length: 10 in. (25 cm)	456507	100
		
High-Flow, four-way stopcock with luer-activated ULTRAPORT port and female luer lock port, 20 in. (50.8 cm) extension tubing, removable 6 in. (15.2 cm) extension tubing with luer lock connection, slide clamp and SPIN-LOCK connector. Priming volume: 4.56 mL. Length: 29 in. (73.7 cm)	456503	50
Same as above, except 35 in. (88.9 cm) extension tubing. Priming volume: 6.45 mL. Length: 43 in. (109.2 cm)	456508	50
		
High-Flow, four-way stopcock with luer-activated ULTRAPORT port and female luer lock port, 26 in. (66 cm) extension tubing, ULTRASITE® injection site, removable 6 in. (15.2 cm) extension tubing with luer lock connection, slide clamp and SPIN-LOCK connector. Priming volume: 6.25 mL. Length: 42 in. (107 cm)	456505	100
		
High-Flow, four-way stopcock with luer-activated ULTRAPORT port and female luer lock port, 26 in. (66 cm) extension tubing, CARESITE® injection site, removable 6 in. (15.2 cm) extension tubing with luer lock connection, slide clamp and SPIN-LOCK connector. Priming volume: 6.25 mL. Length: 42 in. (107 cm)	354222	100

Needleless Anesthesia Manifold Extension Sets

		
Anesthesia Extension Set – normally closed dual manifold*, four-way stopcock, and SPIN-LOCK connector. Priming Volume: 6.8 mL. Length: 41 in. (104 cm)	AET36	472036 50

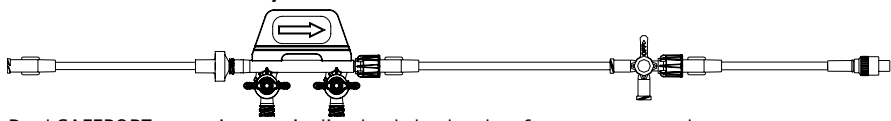
Swabbable Closed System SAFEPORT™ Manifold Extension Set

		
Dual SAFEPORT extension set, in-line backcheck valve, four-way stopcock, and SPIN-LOCK connector. Priming Volume: 7 mL, Length: 41 in. (104 cm)	AET36BC	472038 50
		
Dual swabbable port SAFEPORT extension set with ULTRAPORT high-flow, four-way stopcock and SPIN-LOCK connector. Priming volume: 8.1 mL. Length: 57 in. (144.8 cm)	456524	50

* For injection only

Anesthesia IV Sets

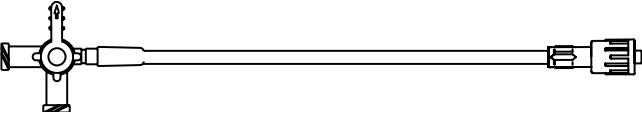
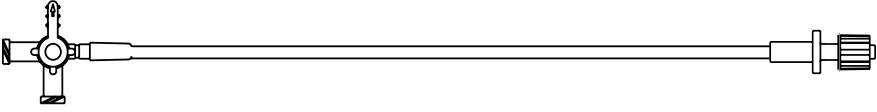
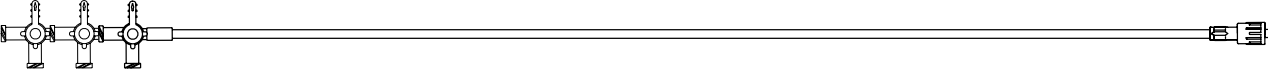
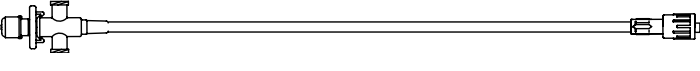
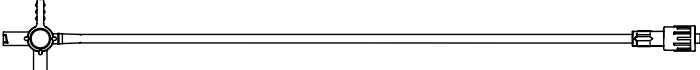
Description	Product Code	REF Number	Units Per cs
Stopcock Extension Sets			
Components on this page do not contain DEHP or natural rubber latex.			
			
Four-way, two female luer lock ports, 9 in. (22.7 cm) extension tubing with SPIN-LOCK® connector, port covers. Priming volume: 1.4 mL. Length: 14 in. (36 cm)	HP509L	454320	100
			
Four-way, two female luer lock ports, 20 in. (50.8 cm) extension tubing with SPIN-LOCK connector, port covers. Priming volume: 1.8 mL. Length: 22 in. (55.9 cm)	D520	456025	50
Same as above, except 33 in. (83.8 cm) extension tubing. Priming volume: 5.5 mL. Length: 35 in. (88.9 cm)	D533	456030	50
			
Three four-way, four female luer lock ports, 40 in. (101.6 cm) extension tubing with SPIN-LOCK connector, port covers. Priming volume: 6 mL. Length: 47 in. (119 cm)	ET123	473054	100
			
Three-way anesthesia stopcock with injection site, two female luer lock ports, 20 in. (50.8 cm) extension tubing with SPIN-LOCK connector, port covers. Priming Volume: 3 mL. Length: 22 in. (56 cm)	D720	473547	50
Same as above, except 37 in. (94 cm) extension tubing. Priming Volume: 5 mL.	D733	473549	50
			
High-flow, four-way, two female luer lock ports, 20 in. (50.8 cm) extension tubing with SPIN-LOCK connector, port covers. Priming Volume: 3.5 mL. Length: 22 in. (56 cm)	D620	473541	50
Same as above, except 33 in. (83.8 cm) extension tubing. Priming volume: 5.9 mL. Length: 37 in. (94 cm)	D633	473543	50

Description	Product Code	REF Number	Units Per cs
-------------	--------------	------------	--------------

Anesthesia IV Administration Sets

Components on this page do not contain DEHP or natural rubber latex.

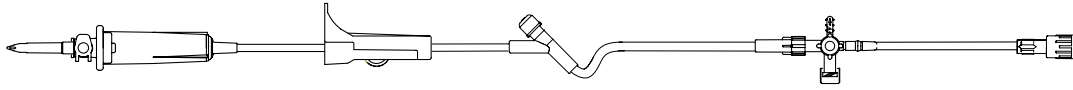

(15 drops/mL)— Universal spike, roller clamp, Injection site, luer lock connection, detachable four-way stopcock with 40 in. extension tubing, distal SPIN-LOCK® connector.
Priming volume: 19.0 mL. Length: 111 in. (282 cm)

AD150DS	351510	50
---------	--------	----

ULTRAPORT™ Needleless Stopcock Anesthesia Sets

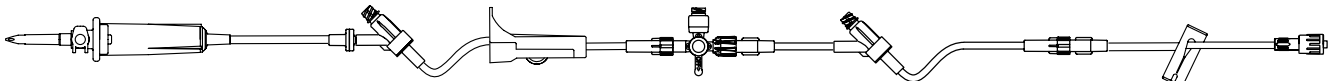

Universal spike (15 drops/mL), backcheck valve, two ULTRASITE® injection sites, roller clamp, removable high-flow, four-way stopcock with luer-activated ULTRAPORT port, female luer lock port, and SPIN-LOCK connector, removable 6 in. (15.2 cm) extension tubing with luer lock connection, slide clamp and SPIN-LOCK connector.
Priming volume: 23 mL. Length: 131 in. (333 cm)

456506	50
--------	----

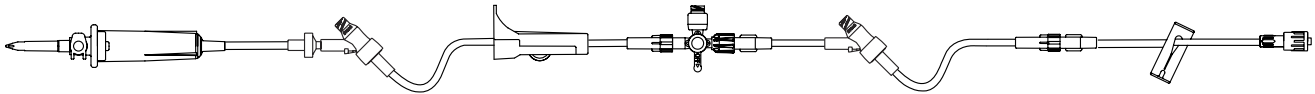

Universal spike (15 drops/mL), backcheck valve, two CARESITE® injection sites, roller clamp, removable high-flow, four-way stopcock with luer-activated ULTRAPORT port, female luer lock port, and SPIN-LOCK connector, removable 6 in. (15.2 cm) extension tubing with luer lock connection, slide clamp and SPIN-LOCK connector.
Priming volume: 23 mL. Length: 131 in. (333 cm)

354209	50
--------	----

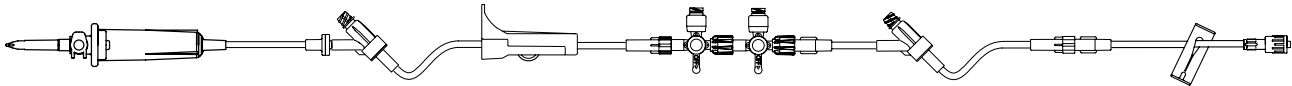

Universal spike (15 drops/mL), backcheck valve, two ULTRASITE injection sites, roller clamp, two removable high-flow, four-way stopcocks with luer-activated ULTRAPORT port, female luer lock port, and SPIN-LOCK connector, removable 6 in. (15.2 cm) extension tubing with luer lock connection, slide clamp and SPIN-LOCK connector.
Priming volume: 24 mL. Length: 130 in. (330 cm)

456504	50
--------	----

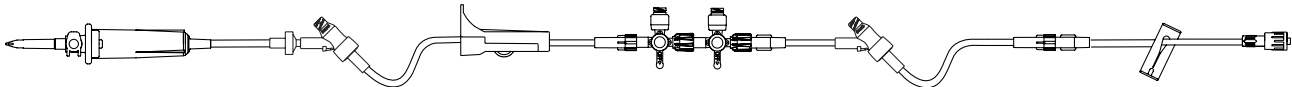

Universal spike (15 drops/mL), backcheck valve, two CARESITE injection sites, roller clamp, two removable high-flow, four-way stopcocks with luer-activated ULTRAPORT port, female luer lock port, and SPIN-LOCK connector, removable 6 in. (15.2 cm) extension tubing with luer lock connection, slide clamp and SPIN-LOCK connector.
Priming volume: 24 mL. Length: 130 in. (330 cm)

354210	50
--------	----

ANESTHESIA IV PRODUCTS

Description	Product Code	REF Number	Units Per cs
-------------	--------------	------------	--------------

Manifold Delivery Sets

Components on this page do not contain DEHP or natural rubber latex.

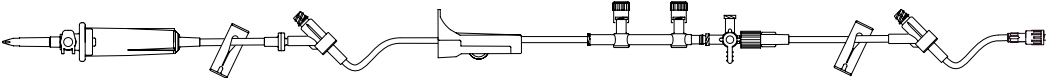

(15 drops/mL) Universal spike, backcheck valve, two ULTRASITE® injection sites, two slide clamps, roller clamp, dual valve manifold* and four-way stopcock with detachable extension set, SPIN-LOCK® connector. Priming Volume: 21 mL, Length: 119 in. (302 cm)

US1260	352393	50
--------	--------	----

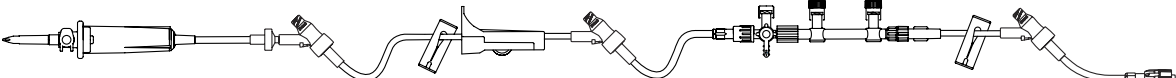

(15 drops/mL) Universal spike, backcheck valve, three CARESITE® injection sites, two slide clamps, roller clamp, detachable normally closed dual manifold* and four-way stopcock, SPIN-LOCK male connector. Priming Volume: 21.3 mL, Length: 125 in. (317.5 cm)

354211	354211	50
--------	--------	----

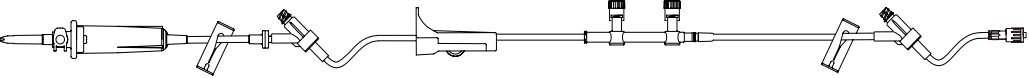

(15 drops/mL) Universal spike, backcheck valve, two ULTRASITE injection sites, two slide clamps, roller clamp, normally closed dual manifold*, SPIN-LOCK male connector. Priming Volume: 21.1 mL, Length: 120 in. (304.8 cm)

US1500M2	352415	50
----------	--------	----

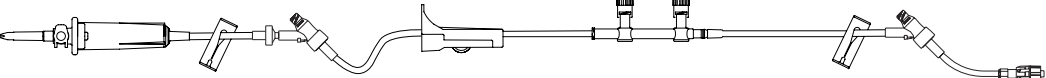

(15 drops/mL) Universal spike, backcheck valve, two CARESITE injection sites, two slide clamps, roller clamp, normally closed dual manifold*, SPIN-LOCK male connector. Priming Volume: 21.1 mL, Length: 120 in. (304.8 cm)

354208	354208	50
--------	--------	----

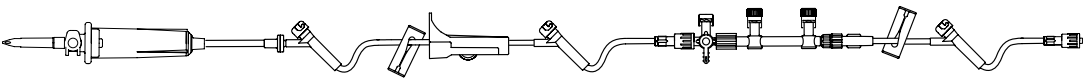

(15 drops/mL), Universal spike, backcheck valve, three SafeLine® injection sites, two slide clamps, roller clamp, removable dual manifold* and four-way stopcock, SPIN-LOCK connector. Priming Volume: 22 mL, Length: 126 in (320 cm)

NF1270A	NF1270A	50
---------	---------	----

Swabbable Closed System SAFEPORT™ Manifold Sets

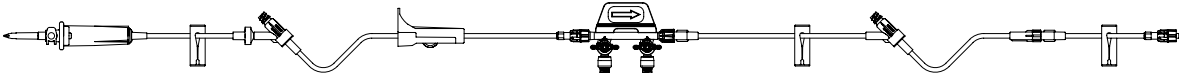

(15 drops/mL) – Universal spike, backcheck valve, 2 ULTRASITE injection sites, 3 slide clamps, roller clamp, dual swabbable port SAFEPORT, SPIN-LOCK connector, removable 6 in. extension tubing. Priming volume: 22 mL. Length: 129 in. (327.7 cm)

456523	456523	50
--------	--------	----



(15 drops/mL) – Universal spike, backcheck valve, 3 ULTRASITE injection sites, 2 slide clamps, roller clamp, ULTRAPORT™ high-flow, four-way stopcock and dual swabbable port SAFEPORT, SPIN-LOCK connector, removable 6 in. extension tubing. Priming volume: 28 mL. Length: 136 in. (345.4 cm)

456525	456525	50
--------	--------	----

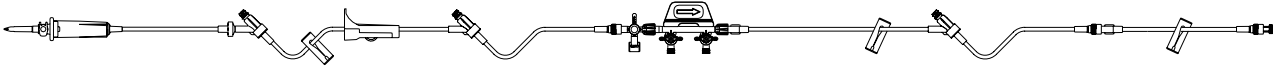

(15 drops/mL) Universal spike, backcheck valve, 3 ULTRASITE injection sites, 3 slide clamps, roller clamp, detachable, dual SAFEPORT™ manifold*, four-way stopcock, detachable 6 in. extension set, SPIN-LOCK male connector. Priming Volume: 23 mL, Length: 136 in. (345 cm)

US1275A	US1275A	50
---------	---------	----

* For injection only

Description	Product Code	REF Number	Units Per cs
-------------	--------------	------------	--------------

Basic IV Administration Sets

Components on this page do not contain DEHP or natural rubber latex.

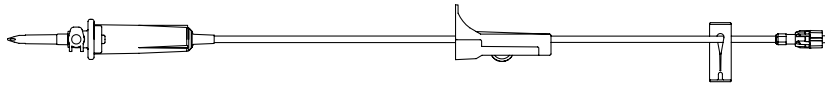

(15 drops/mL) Universal spike, roller clamp, slide clamp, and SPIN-LOCK® connector. Priming Volume: 13 mL, Length: 85 in. (215.9 cm). Labeled "Contents Sterile".

V1501	352601	50
-------	--------	----

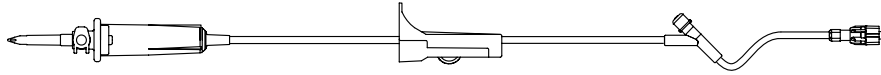

(15 drops/mL) Universal spike, roller clamp, slide clamp, injection site 26 inches above distal end, SPIN-LOCK connector. Priming Volume: 19 mL, Length: 93 in. (236.2 cm)

V1415-15	V1415-15	50
----------	----------	----

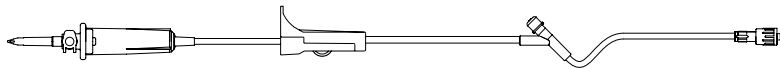

(15 drops/mL) Universal spike, roller clamp, injection site 6 inches above distal end, SPIN-LOCK connector. Priming Volume: 16 mL, Length: 81 in. (205.7 cm)

V1390	V1390	50
-------	-------	----

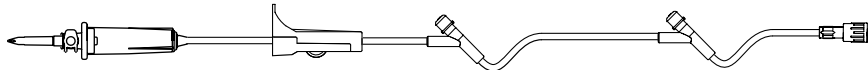

(15 drops/mL) Universal spike, roller clamp, injection sites 28 inches and 6 inches above distal end, SPIN-LOCK connector. Priming Volume: 18 mL, Length: 84 in. (213.4 cm)

V1421-20	V1421-20	50
----------	----------	----

Mini-Drop Basic Administration Set

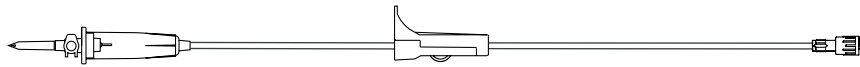

(60 drops/mL) Universal spike, roller clamp, SPIN-LOCK connector. Priming Volume: 13 mL, Length: 67 in. (170.2 cm)

V1425-15	V1425-15	50
----------	----------	----

Secondary Administration Set for Use with ADDitIV® Primary Administration Sets



(15 drops/mL) Universal spike, roller clamp, SPIN-LOCK connector, with plastic bag hanger. Priming Volume: 8.8 mL, Length: 40 in. (101.6 cm).

V1921	V1921	50
-------	-------	----

Basic Y-Type Administration Set



(15 drops/mL) 2 Universal spikes, two roller clamps, roller clamp, injection site, SPIN-LOCK connector. Priming Volume: 25 mL, Length: 86 in. (218 cm)

V1500	V1500	50
-------	-------	----

IV ADMINISTRATION SETS

Description	Product Code	REF Number	Units Per cs
ADDitIV® Primary Filtered Administration Set with Backcheck Valve and 0.2 micron Filter			
Components on this page do not contain DEHP or natural rubber latex.			
(15 drops/mL) Universal spike, backcheck valve, 0.2 micron filter, 3 injection sites, roller clamp, slide clamp, SPIN-LOCK® connector. Priming Volume: 20 mL, Length: 83 in. (211 cm).	V1782F	352447	50
Filterflow® Primary Filtered IV Administration Set with 1.2 micron Filter			
(15 drops/mL) Vista® Dual Application Gravity and Pump Set - Universal spike, slide clamp, roller clamp, 1.2 micron filter, slide clamp, 1 injection site and SPIN-LOCK connector. Priming Volume: 19 mL, Length: 106 in. (269 cm).	V8812F	352401	50
Filterflow® Filtered Administration Set with 0.2 micron Filter			
(15 drops/mL) Universal spike, 0.2 micron filter, roller clamp, slide clamp, 1 injection site and SPIN-LOCK connector. Priming Volume: 21 mL, Length: 89 in. (226 cm).	V1792F	352424	50

Description	Product Code	REF Number	Units Per cs
-------------	--------------	------------	--------------

PERIPHERAL EXTENSION SETS

Standard Bore Extension Sets

Components on this page do not contain DEHP or natural rubber latex.

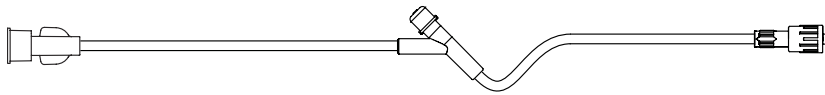

Female luer connector, injection site 4 inches above distal end, distal SPIN-LOCK® connector. Priming volume: 1.2 mL. Length: 7.5 in. (19 cm) V5402 V5402 50

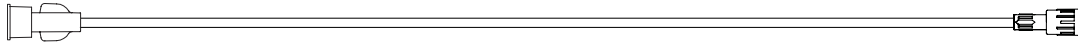

Female luer connector, distal SPIN-LOCK connector. Priming volume: 3 mL. Length 21 in. (52.5 cm) V5406 V5406 50

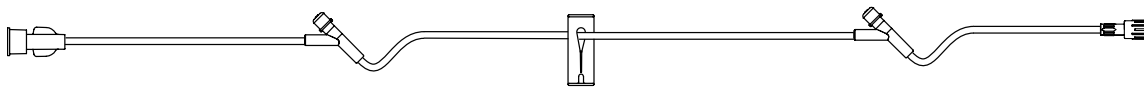

Female luer connector, injection sites 24 and 6 inches above distal end, slide clamp, distal SPIN-LOCK connector. Priming volume: 5 mL. Length: 34 in. (86.2 cm) V5409 V5409 50

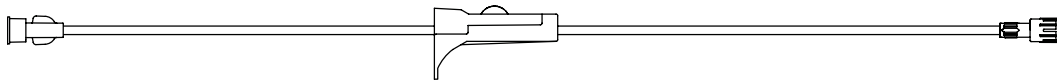

Female luer connector, large bore tubing, roller clamp, distal SPIN-LOCK connector. Priming volume: 4.5 mL. Length: 31 in. (78.5 cm) V5484 V5484 50

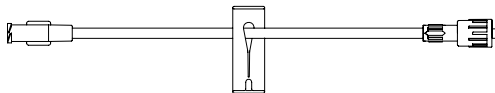

Female luer connector, distal SPIN-LOCK connector. Priming volume: 1 mL. Length: 7 in. (18 cm) ET06L 471975
100

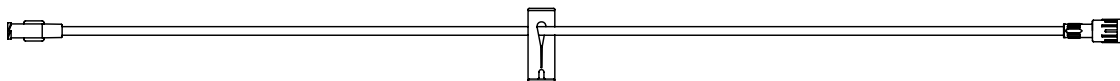

Female luer connector, slide clamp, distal SPIN-LOCK connector. Priming volume: 4.3 mL. Length: 30 in. (76 cm) ET30LC 473012 100

Standard Bore T-Port Extension Sets

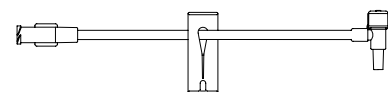

Female luer connector, slide clamp, distal T-port with male luer slip connector. Priming volume: 0.6 mL. Length: 6 in. (15 cm) ET04TR 471949 100

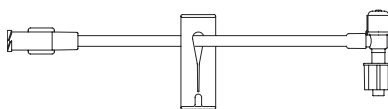

Female luer connector, slide clamp, distal T-port with SPIN-LOCK® connector. Priming volume: 0.6 mL. Length: 6 in. (15 cm) ET04TSR 471953 100

IV ADMINISTRATION SETS

Description	Product Code	REF Number	Units Per cs
-------------	--------------	------------	--------------

PERIPHERAL EXTENSION SETS

Backcheck Valve Extension Sets

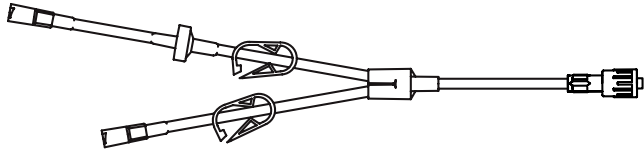

Y-type with 2 female luer lock connectors, backcheck valve, 2 on/off clamps, distal SPIN-LOCK® connector. Components do not contain DEHP or natural rubber latex. Priming volume: 1.8 mL. Length: 10 in. (25 cm)

ET08YL 471980 50

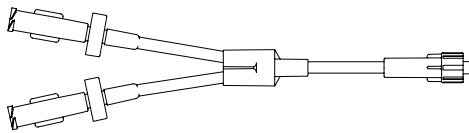

Y-type with 2 proximal female luer lock connectors, 2 dual backcheck valves, distal male luer lock connector. Components do not contain natural rubber latex. Priming volume: 1.5 mL. Length: 6 in. (15 cm)

ET06YLV 471979 100

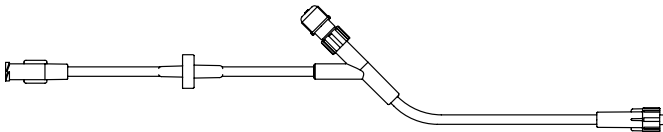

Female luer connector, backcheck valve above injection site, with IN4000 injection cap attached, distal male luer lock connector. Components do not contain natural rubber latex. Priming volume: 2 mL. Length 8 in. (20 cm)

ET107 473007 100

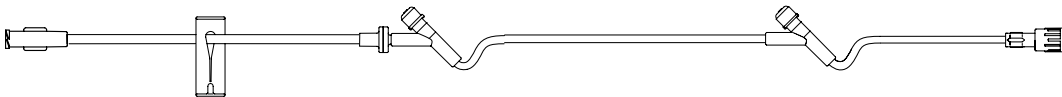

Female luer connector, slide clamp, backcheck valve, injection sites 18 and 16 inches above distal end, male luer lock connector. Components do not contain DEHP or natural rubber latex.

V5405 V5405 50

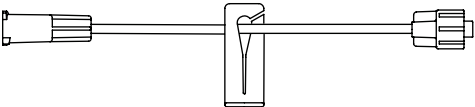
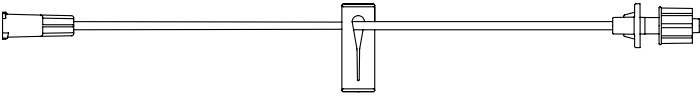
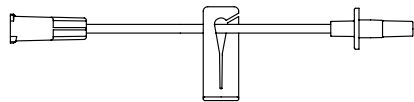
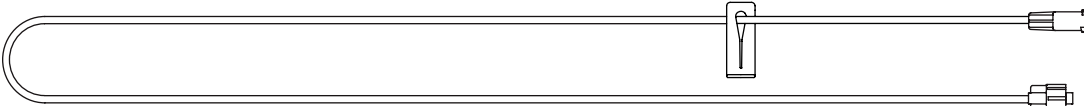
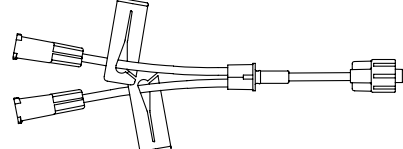
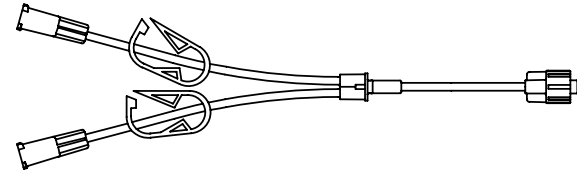
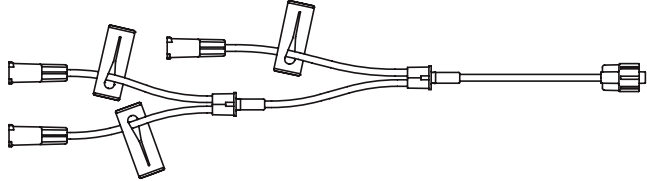
Description	Product Code	REF Number	Units Per cs
PERIPHERAL EXTENSION SETS			
Small Bore Extension Sets			
Components on this page do not contain DEHP or natural rubber latex.			
	ET06S	471960	100
Female luer connector, removable slide clamp, distal male luer lock connector. Priming volume: 0.2 mL. Length: 6 in. (15.2 cm)			
	ET12SB	473105	100
Female luer connector, non-removable slide clamp, distal SPIN-LOCK® connector. Priming volume: 0.4 mL. Length 13 in. (31.0 cm)			
	ET06LS	471991	100
Female luer connector, removable slide clamp, distal male luer slip connector. Priming volume: 0.2 mL. Length: 6 in. (15.2 cm)			
	ET112	471973	100
Female luer connector, slide clamp, distal male luer lock connector. Priming volume: 2 mL. Length: 61 in. (155 cm)			
	ET06MDA	471957	100
Y-type with 2 female luer connectors, 2 removable slide clamps, distal male luer lock connector. Priming volume: 0.5 mL. Length: 6 in. (15 cm)			
	ET103	471959	100
Y-type with 2 female luer lock connectors, 2 on/off clamps and distal male luer lock connector. Priming volume: 0.5 mL. Length: 8 in. (20 cm)			
	ET110	473041	100
Triple-leg set with 3 female luer connectors, 3 non-removable slide clamps, distal male luer lock connector. Priming volume: 0.5 mL. Length: 9 in. (23 cm)			

IV ADMINISTRATION SETS

Product Code REF Number Units Per cs

Description

PERIPHERAL EXTENSION SETS

Small Bore T-Port Extension Sets

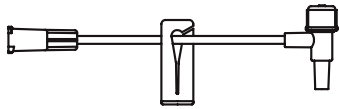

Female luer lock connector, removable slide clamp, distal T-port with male luer slip connector. Components do not contain DEHP or natural rubber latex. Priming volume: 0.3 mL. Length: 5 in. (13 cm)

ET04T 471950 100

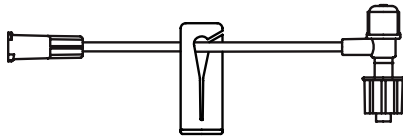

Female luer lock connector, removable slide clamp, distal T-port with SPIN-LOCK® connector. Components do not contain DEHP or natural rubber latex. Priming volume: 0.1 mL. Length: 4 in. (10.2 cm)

ET04TS 471954 100



Female luer lock connector, on/off clamp, distal T-port with male luer slip connector. Components do not contain DEHP or natural rubber latex. Priming volume: 0.3 mL. Length: 7 in. (18 cm)

ET06THR 471962 100

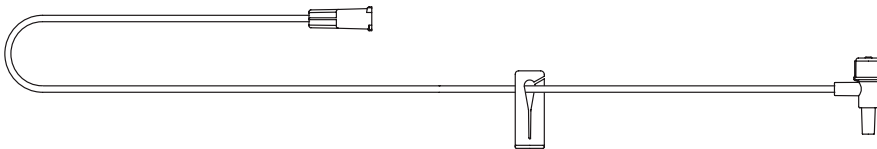

Female luer lock connector, removable slide clamp, distal T-port with male luer slip connector. Components do not contain natural rubber latex. Priming volume: 1.2 mL. Length: 38 in. (97 cm)

ET38T 473022 100



Female luer lock connector, normally closed backcheck valve, removable slide clamp, distal T-port with male luer slip connector. Components do not contain DEHP or natural rubber latex. Priming volume: 1.1 mL. Length: 31 in. (76 cm)

ET30TCV 473009 100

Description	Product Code	REF Number	Units Per cs
-------------	--------------	------------	--------------

Syringe Pump PVC-free Fluid Path Microbore Extension Sets

Components on this page do not contain natural rubber latex.

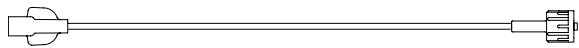

Female luer and distal male luer lock. Microbore extension set, 0.02 in. ID. tubing with fluid path that does not contain PVC. Priming volume: 0.3 mL, Length: 36 in. (91 cm)

V6220 V6220 50

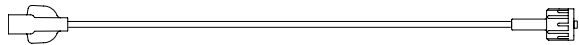

Female luer and distal male luer lock. Microbore extension set, 0.03 in. ID. tubing with fluid path that does not contain PVC. Use with higher flow rates and viscous fluids. Priming volume: 0.6 mL, Length: 36 in. (91 cm)

V6203 V6203 50

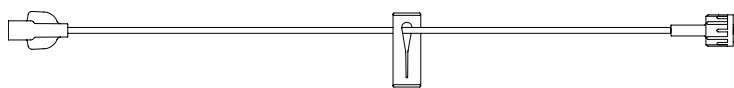

Female luer and distal male luer lock. Microbore extension set, 0.02 in. ID. tubing with fluid path that does not contain PVC. Priming volume: 0.5 mL, Length: 60 in. (152 cm)

V6222 V6222 50

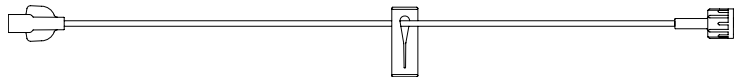

Female luer and distal male luer lock. Microbore extension set, 0.03 in. ID. with fluid path that does not contain PVC. Use with higher flow rates and viscous fluids. Priming volume: 0.8 mL, Length: 60 in. (152 cm)

V6223 V6223 50



Female luer and distal male luer lock. Microbore extension set, 0.2 micron filter, 0.03 in. ID. tubing with fluid path that does not contain PVC. Priming volume: 1.3 mL, Length: 60 in. (152 cm)

V6215 V6215 50

Syringe Pump Microbore Extension Sets with Proximal and Distal Male Luer Locks

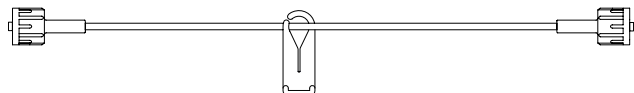

Proximal and distal male luer locks. Microbore extension set, 0.04 in. ID., removable slide clamp. Priming volume: 0.7 mL, Length: 31 in. (79 cm)

V5450 V5450 50

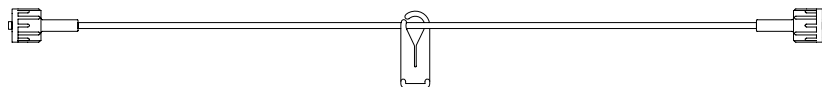

Proximal and distal male luer locks. Microbore extension set, 0.04 in. ID., removable slide clamp. Priming volume: 1.2 mL, Length: 63 in. (160 cm)

V5456 V5456 50

Microbore Extension Set

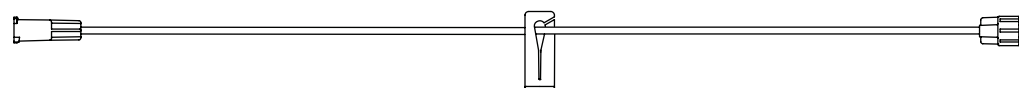

Female luer connector, removable slide clamp, male luer lock connector. Priming volume: 0.6 mL. Length 19 in. (48 cm)

V5424 V5424 50

IV ADMINISTRATION SETS

Description	Product Code	REF Number	Units Per cs
-------------	--------------	------------	--------------

Filterflow® Small Bore FILTERED EXTENSION SETS

with 0.2 micron low volume filter

Components on this page do not contain DEHP or natural rubber latex.

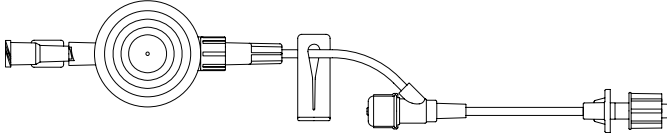

Female luer connector, 0.2 micron low volume SUPOR® filter, slide clamp, injection site 3 inches above distal end, SPIN-LOCK® connector. Priming Volume: 1.2 mL, Length: 8 in. (20 cm).	PFE2007	352205	50
---	---------	--------	----

with 0.2 micron micro volume filter

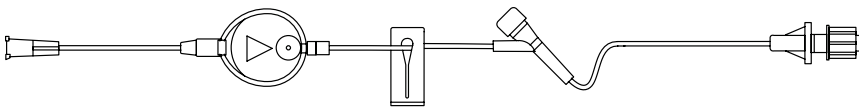

Female luer connector, 0.2 micron micro volume SUPOR filter, slide clamp, injection site 3 inches above distal end, SPIN-LOCK connector. Priming Volume: 0.7 mL, Length: 7 in. (18 cm).	MFE2007	473061	50
---	---------	--------	----

with 1.2 micron low volume air-eliminating filter

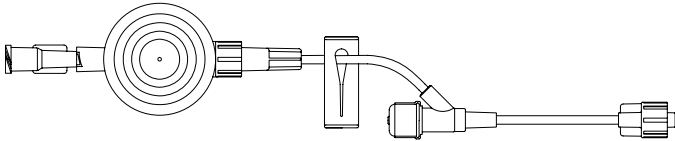

1.2 micron SUPOR® low-volume air-eliminating in-line filter with slide clamp, small bore tubing, injection site and luer lock connection. Priming Volume: 0.9 mL, Length: 8 in. (20 cm).	PFE1207	352212	50
--	---------	--------	----

0.2 micron low volume add-on filter

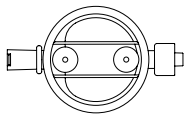

0.2 micron SUPOR Low Volume air-eliminating IV filter with female luer lock and SPIN-LOCK connectors. Priming Volume: 0.8 mL.	PFE2000	473036	50
---	---------	--------	----

SUPOR is a registered trademark of the Pall Corporation

Description	Product Code	REF Number	Units Per cs
-------------	--------------	------------	--------------

FILTERED EXTENSION SETS

with 0.2 micron air-eliminating filter

Components on this page do not contain DEHP or natural rubber latex.

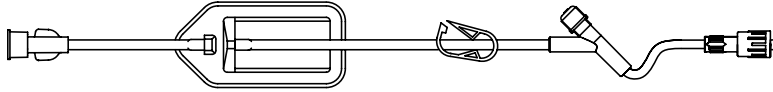

Female luer connector, 0.2 micron filter, 1 injection site, on/off clamp and SPIN-LOCK® connector. Priming Volume: 5.1 mL, Length: 16 in. (40.6 cm).	FE2012F	473989	50
---	---------	--------	----

with 1.2 micron air-eliminating filter

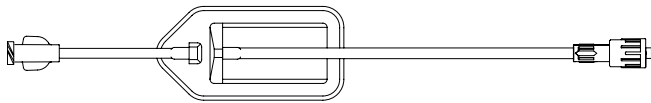

1.2 micron air-eliminating filter with luer lock connector. Priming Volume: 4.3 mL, Length: 10 in. (25 cm)	FE1209F	473994	50
--	---------	--------	----

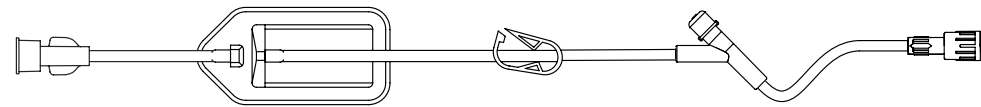

1.2 micron air-eliminating filter with 1 injection site and SPIN-LOCK connector. Priming Volume: 5.1 mL, Length: 16 in. (40.6 cm)	FE1212F	473995	50
--	---------	--------	----

with 5.0 micron air-eliminating filter

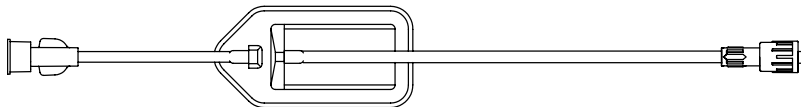

5.0 micron air-eliminating in-line filter with female luer connector, male SPIN-LOCK connector. Priming volume: 3.6 mL, Length: 10 in. (25.4 cm).	FE5009F	474002	50
--	---------	--------	----

SUPOR is a registered trademark of the Pall Corporation

IV ADMINISTRATION SETS

Description	Product Code	REF Number	Units Per cs
-------------	--------------	------------	--------------

BLOOD ADMINISTRATION SETS

Components on this page do not contain natural rubber latex.

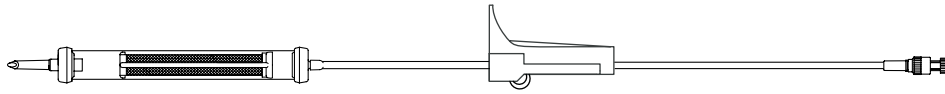

(10 drops/mL) Drip chamber with 170 micron blood filter, roller clamp, SPIN-LOCK® connector. Priming volume: 31 mL, Length: 76 in. (193 cm)

V2400 V2400 50

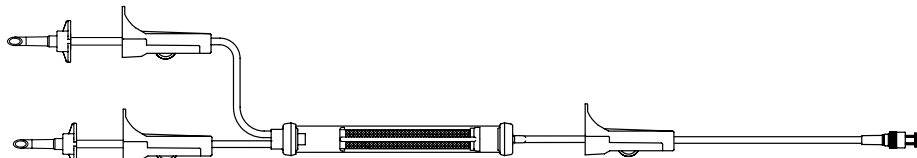

(10 drops/mL) Y-Type, three roller clamps, drip chamber with 170 micron blood filter, SPIN-LOCK connector. Priming volume: 34 mL, Length: 87 in. (221 cm)

V2500 V2500 50

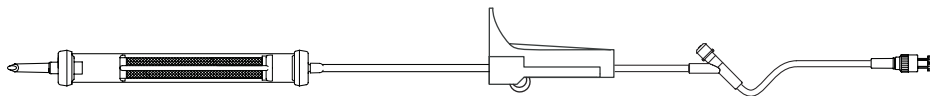

(10 drops/mL) Drip chamber with 170 micron blood filter, roller clamp, injection site 6 inches above the distal end, SPIN-LOCK connector. Priming volume: 30 mL, Length: 75 in. (191 cm)

V2410 V2410 50

Blood Administration Sets with Hand Pump

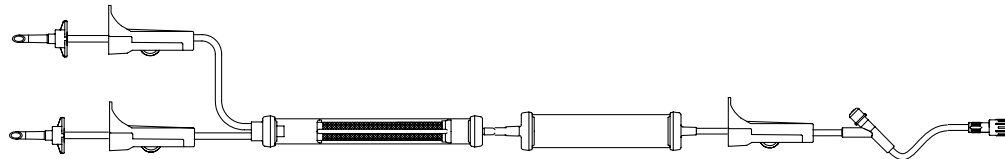

(10 drops/mL) Y-Type, three roller clamps, drip chamber with 170 micron blood filter, pump chamber, injection site 6 inches above distal end, SPIN-LOCK connector. Priming volume: 69 mL. Length: 85 in. (216 cm)

V2560 V2560 50

Same as V2560, except 148 in. (376 cm) in length. Priming volume: 80 mL

V2560-39 V2560-39 50

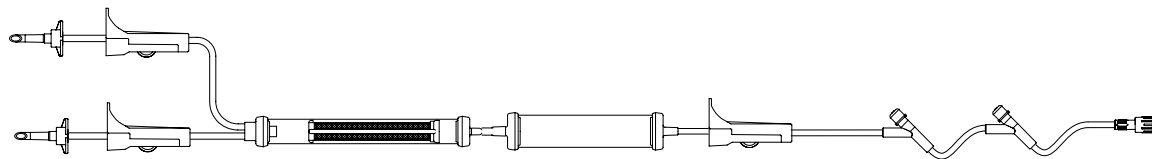

(10 drops/mL) Y-Type, three roller clamps, drip chamber with 170 micron blood filter, pump chamber, injection sites 6 and 41 inches above distal end, SPIN-LOCK connector. Priming volume: 71 mL. Length: 98 in. (249 cm)

V2560-37 V2560-37 50

Description	Product Code	REF Number	Units Per cs
-------------	--------------	------------	--------------

BLOOD ADMINISTRATION ACCESSORIES

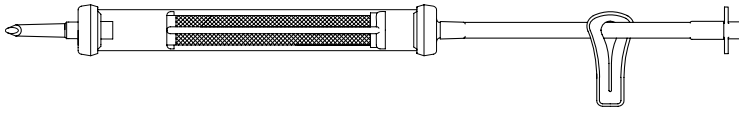

(10 drops/mL) Drip chamber with 170 micron blood filter, slide clamp, spike adapter. Components do not contain natural rubber latex. Priming volume: 19 mL. Length: 9 in. (23 cm)

V2950

V2950

50

Plasma Transfer Administration Set

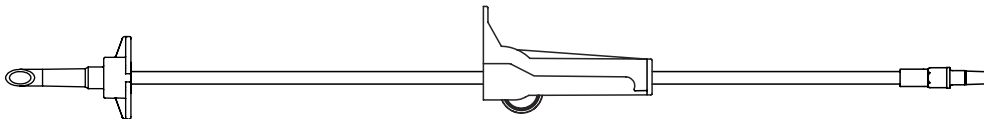

Non-vented spike, roller clamp, male luer slip connector. Priming volume: 16 mL Length: 27 in. (68.6 cm) Components do not contain DEHP or natural rubber latex.

V2203

V2203

50

MEASURED VOLUME SOLUTION BURETTE SETS

Mini-Drop Administration Set with Float Valve Automatic Shutoff

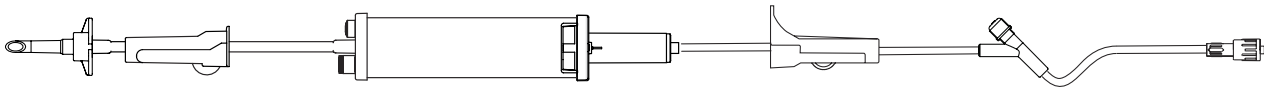

(60 drops/mL) Non-vented spike, roller clamp, 150 mL burette chamber, roller clamp, injection site 6 inches above distal end, SPIN-LOCK® connector. Components do not contain natural rubber latex. Priming Volume: 15 mL, Length: 87 in. (221.0 cm)

V1429M

375113

20

Add-On Set without Automatic Shutoff

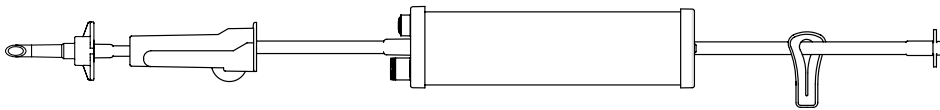

Non-vented spike, roller clamp, 150 mL burette chamber, slide clamp, spike adapter. Components do not contain natural rubber latex. Priming Volume: 3 mL, Length: 20 in. (51.0 cm)

375112

20

IV ADMINISTRATION SETS

Product Code REF Number Units Per cs

Description

RATE FLOW® REGULATOR ADMINISTRATION SETS

Extension Set with Rate Flow Regulator

Components on this page do not contain DEHP or natural rubber latex.

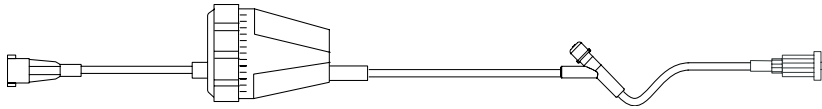

Rate Flow Regulator with female luer connector, injection site 6 inches above distal end, SPIN-LOCK® connector. Priming volume: 2.6 mL. Length: 18 in. (46 cm)

V5200 V5200 50

IV Administration Set with Rate Flow Regulator

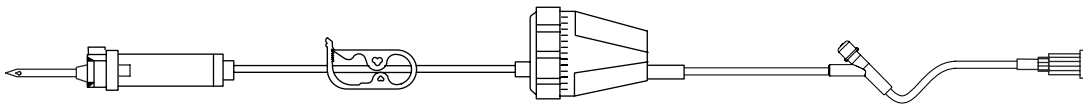

(20 drops/mL) Universal spike with 15 micron filter, on/off clamp, Rate Flow Regulator, injection site 6 inches above distal end, SPIN-LOCK connector. Priming volume: 16.5 mL. Length: 83 in. (210.8 cm)

V5922 V5922 50

Mini-Drop IV Administration Set with Rate Flow Regulator

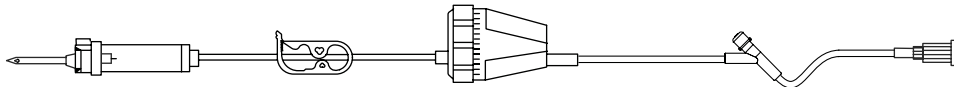

(60 drops/mL) Universal with spike, 15 micron filter, on/off clamp, Rate Flow Regulator, injection site 6 inches above distal end, SPIN-LOCK connector. Priming volume: 16.5 mL. Length: 83.27 in. (211.5 cm)

V5926 V5926 50

ADDitIV® Primary Administration Set with Backcheck Valve and Rate Flow Regulator

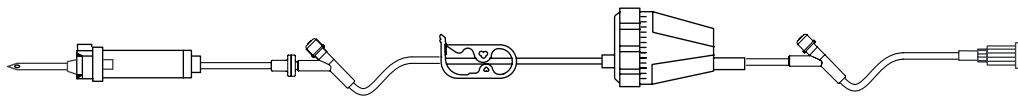

(20 drops/mL) Universal spike with 15 micron filter, backcheck valve, on/off clamp, Rate Flow Regulator, injection sites 54 and 6 inches above distal end, SPIN-LOCK connector. Priming volume: 17.5 mL. Length: 89.37 in. (227 cm)

V5932 V5932 50

Emergency Medical Services Set with Rate Flow Regulator

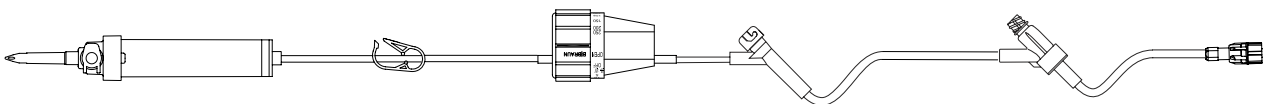

(20 drops/mL) Universal spike with 15 micron filter, on/off clamp, Rate Flow Regulator, SAFELINE injection site, ULTRASITE injection site, SPIN-LOCK connector. Priming volume: 17 mL. Length: 89 in. (225 cm)

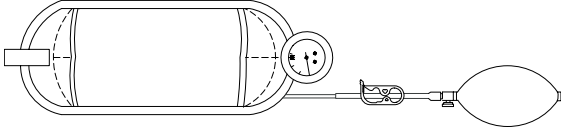

USNF5932 375173 50

Description	Product Code	REF Number	Units Per cs
SPECIAL ACCESSORIES			
Pressure Administration Cuff			
			
Pressure Administration Cuff for rapid administration of IV fluids from bags. Components contain no natural rubber latex.	N5062	N5062	1

Warm Paks



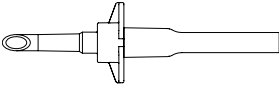
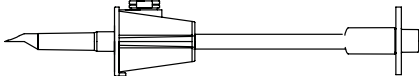
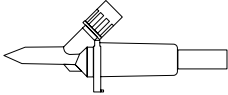

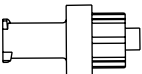
			
T-Pak® I.V. Instant Warm Pak, for external application for vein dilation. Four 10-pack cartons.	N6115	N6115	40

SPECIAL APPLICATION ACCESSORIES

			
Spike Adapter . Components contain no natural rubber latex.	N2050	N2050	24
			
Vented Spike Adapter. Components contain no natural rubber latex.	N2061	N2061	50
			
Vented Spike Adapter- permits connection of non-vented IV spike to IV bottle requiring a vent. Components contain no natural rubber latex.	SA2000	418105	20
			
Dual Male Adapter -male luer lock connector and distal SPIN-LOCK® connector. Connects two female luer connections. Components contain no DEHP or natural rubber latex. Priming volume: 0.1 mL	DMA1000	456080	100
			
Normally Closed Check Valve/Antisiphon Valve - requires syringe pressure to open, luer lock. Components contain no DEHP or natural rubber latex. Priming volume: 0.12 mL	BC1000	415062	100

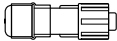
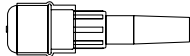
T-Pak is a registered trademark of CareFusion Corporation

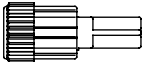

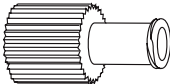
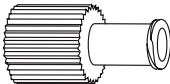
IV ADMINISTRATION SETS

Description	Product Code	REF Number	Units Per cs
INJECTION CAPS			
			
Intermittent Injection Cap – opaque yellow body, proximal self-sealing injection port, distal male luer lock connector with recessed luer taper. Components contain no DEHP or natural rubber latex. Priming volume: 0.16 mL. Length: 0.875 in. (2.2 cm)	IN1000	654237	1000
			
Intermittent Injection Cap – proximal injection port, clear body, distal male luer lock connector. Components contain no DEHP or natural rubber latex. Priming volume: 0.2 mL. Length: 1.125 in. (2.9 cm)	IN2000	418020	100
			
Intermittent Injection Cap – proximal injection port, distal luer slip connector. Components contain no DEHP or natural rubber latex. Priming volume: 0.2 mL. Length: 1.125 in. (2.9 cm)	IN3000	418025	100
			
Intermittent Injection Cap – proximal injection port, distal male luer lock connector. Components contain no DEHP or natural rubber latex. Priming volume: 0.1 mL. Length: 0.75 in. (1.9 cm)	IN4000	418030	100
REPLACEMENT CAPS			
			
Blue Replacement Cap – male luer lock.	B1000	418017	100
Blue Replacement Cap – bulk pack of 1,000 in dispenser boxes of 100 each.	B1000B	418027	1000
			
Replacement Caps – blue male luer lock cap and white female luer lock cap.	BW1000	BW1000	100
			
White Replacement Cap – female luer lock.	W1000	474900	100
			
RED CAP™ luer cap – Dual function red cap with male and female end. Bulk pack of 1,000 in dispenser boxes of 100 each.	R2000B	R2000B	1000
			
Blue Cap luer cap – Dual function blue cap with male and female end. Bulk pack of 1,000 in dispenser boxes of 100 each.	B2000B	B2000B	1000

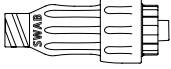
CARESITE® (LAD) System

Description	Product Code	REF Number	Units Per cs
CARESITE (LAD)  CARESITE (LAD) valve for aspiration, injection or gravity flow of fluid upon insertion of a male luer fitting. Components do not contain DEHP or natural rubber latex. Priming volume: 0.22 mL. Power injection rated to 300 psi and 10 mL/sec	415122	415122	200

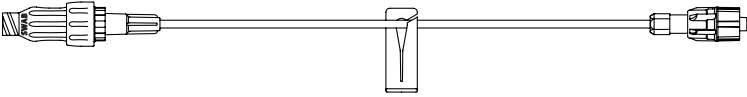
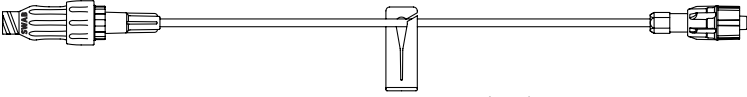
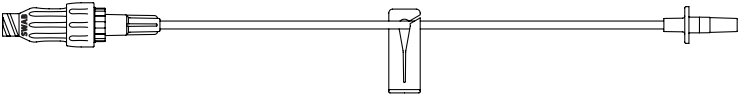
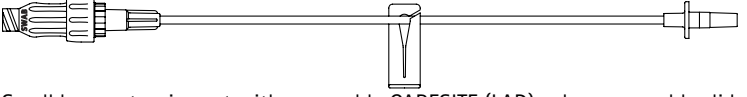
CARESITE Small Bore Extension Sets

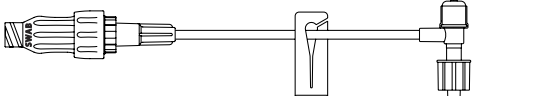
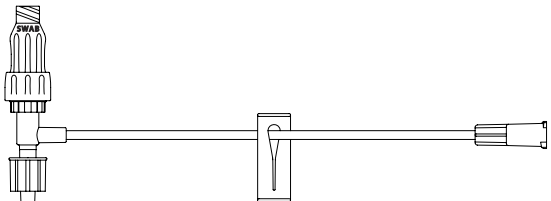
	Small bore extension set with bonded CARESITE (LAD) valve, removable slide clamp, SPIN-LOCK® connector. Components do not contain DEHP or natural rubber latex. Priming volume: 0.5 mL, Length: 8 in. (20 cm). Power injection rated to 300 psi and 10 mL/sec.	470100	470100	100
	Small bore extension set with removable CARESITE (LAD) valve, removable slide clamp, SPIN-LOCK connector. Components do not contain DEHP or natural rubber latex. Priming volume: 0.5 mL, Length: 8 in. (20 cm)	470101	470101	100
	Small bore extension set with bonded CARESITE (LAD) valve, removable slide clamp, male luer slip connector. Components do not contain DEHP or natural rubber latex. Priming volume: 0.5 mL, Length: 8 in. (20 cm)	470102	470102	100
	Small bore extension set with removable CARESITE (LAD) valve, removable slide clamp, male luer slip connector. Components do not contain DEHP or natural rubber latex. Priming volume: 0.5 mL, Length: 8 in. (20 cm)	470103	470103	100
	Small bore extension set with bonded CARESITE (LAD) valve, removable slide clamp, SPIN-LOCK connector. Components do not contain DEHP or natural rubber latex. Priming volume: 0.7 mL, Length: 14 in. (36 cm)	470104	470104	100
	Small bore extension set with removable CARESITE (LAD) valve, removable slide clamp, SPIN-LOCK connector. Components do not contain DEHP or natural rubber latex. Priming volume: 0.7 mL, Length: 14 in. (36 cm)	470105	470105	100
	Small bore T-Port Extension Set with removable CARESITE (LAD), Injection Site on SPIN-LOCK T-Port, and removable slide clamp. Priming volume: 0.5 mL, Length: 6 in. (15.0 cm)	470111	470111	100
	Small bore T-Port Extension Set with Female Luer Lock Connector and CARESITE (LAD) on SPIN-LOCK T-Port and slide clamp. Priming volume: 0.5 mL, Length: 5 in. (13.0 cm)	470114	470114	100

NEEDLELESS PRODUCTS

CARESITE® (LAD) System

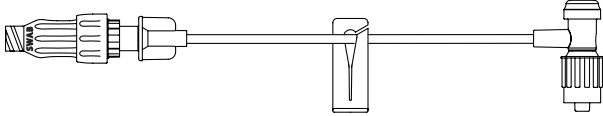
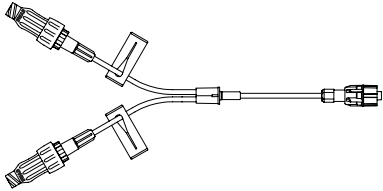
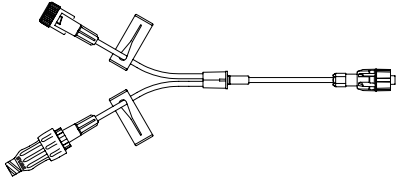
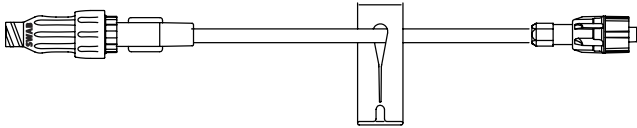
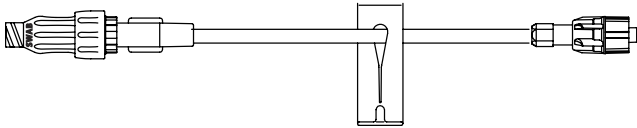
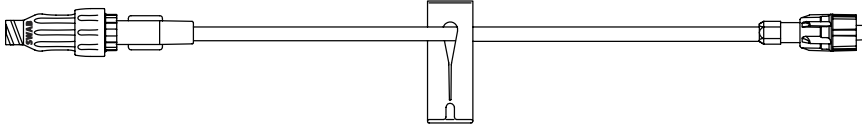
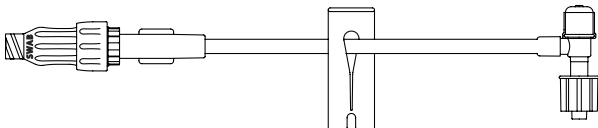
Description	Product Code	REF Number	Units Per cs
CARESITE Small bore Extension Sets			
Components on this page do not contain DEHP or natural rubber latex.			
	470128	470128	50
Small bore T-Port Extension Set with CARESITE (LAD), SafeLine® Injection Site on T-Port, removable slide clamp, and PE Fluid Path Tubing. Priming volume: 0.3 mL, Length: 7 in. (18 cm)			
	470106	470106	50
Small bore Y-extension set with two bonded CARESITE (LAD) valves, two slide clamps, SPIN-LOCK® connector. Priming volume: 0.9 mL, Length: 7 in. (18 cm)			
	470107	470107	50
Small bore Y-extension set with one removable CARESITE (LAD) valve, two slide clamps, SPIN-LOCK connector. Priming volume: 0.9 mL, Length: 7 in. (18 cm)			
CARESITE Standard Bore Extension Sets			
	470108	470108	100
Standard bore extension set with bonded CARESITE (LAD) valve, slide clamp, SPIN-LOCK connector. Priming volume: 0.9 mL, Length: 6 in. (15 cm)			
	470109	470109	100
Standard bore extension set with removable CARESITE (LAD) valve, slide clamp, SPIN-LOCK connector. Priming volume: 0.9 mL, Length: 6 in. (15 cm)			
	470124	470124	100
For use with power injectors – maximum 300 psi and maximum flow rate 10 mL/sec Standard bore extension set with bonded CARESITE (LAD) valve, kink-resistant tubing, slide clamp, SPIN-LOCK connector. Priming volume: 0.5 mL, Length: 8 in. (20 cm) Power injection rated to 300 psi and 10 mL/sec			
	470112	470112	100
Small bore T-Port extension set with removable CARESITE (LAD) valve, slide clamp and injection site on SPIN-LOCK T-Port. Priming volume: 1.5 mL, Length: 8 in. (20 cm)			

CARESITE® (LAD) System

Description	Product Code	REF Number	Units Per cs
-------------	--------------	------------	--------------

CARESITE Standard Bore Extension Sets

Components on this page do not contain DEHP or natural rubber latex.

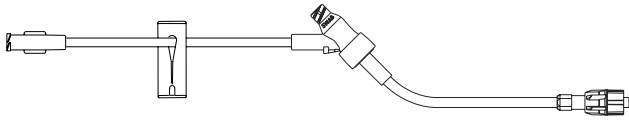

Standard bore extension set with non-removable slide clamp, CARESITE valve injection site, SPIN-LOCK® connector. Priming volume: 1.54 mL, Length: 8 in. (20 cm)

354219 354219 50

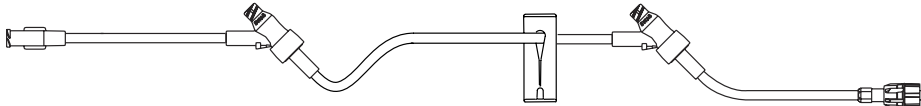

Standard bore extension set with two CARESITE valve injection sites 28 in. and 6 in. above distal end, non-removable slide clamp, SPIN-LOCK connector. Priming volume: 5.4 mL, Length: 35 in. (89 cm)

354220 354220 50

Filterflow® Filtered Extension Sets with CARESITE Injection Site

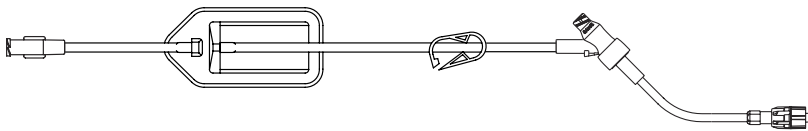

0.2 micron filter, CARESITE valve injection site 6 in. above distal end, on/off clamp, SPIN-LOCK connector. Priming volume: 5.2 mL, Length: 16 in. (40.6 cm)

354221 354221 50

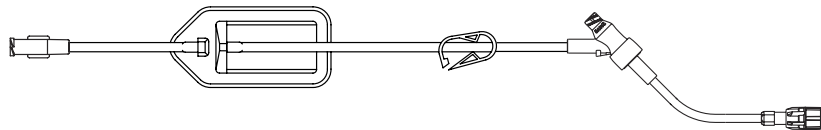

1.2 micron filter, CARESITE valve injection site 6 in. above distal end, on/off clamp, SPIN-LOCK connector. Priming volume: 4.5 mL, Length: 16 in. (40.6 cm)

470117 470117 50

Filterflow Filtered Administration Set with CARESITE Injection Sites

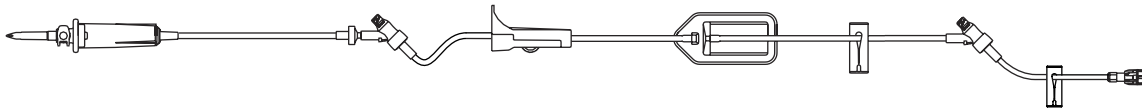

15 drops/mL) Universal spike, backcheck valve, CARESITE injection sites 87 in. and 6 in. above distal end, roller clamp, 0.2 micron filter, slide clamp, SPIN-LOCK connector. Priming volume: 21.2 mL, Length: 104 in. (264.2 cm)

354207 354207 50

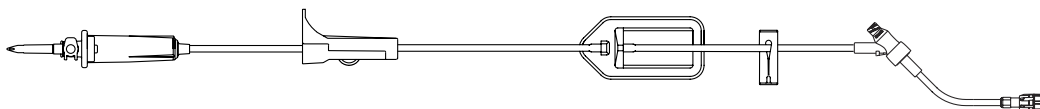

(15 drops/mL) Universal spike, roller clamp, 1.2 micron filter, slide clamp, CARESITE injection site 6 in. above distal end, SPIN-LOCK connector. Priming volume: 18.9 mL, Length 91 in. (231.1cm)

470115 470115 50

CARESITE® (LAD) System

Description	Product Code	REF Number	Units Per cs
-------------	--------------	------------	--------------

Gravity IV Administration Sets with CARESITE Injection Sites

Components on this page do not contain DEHP or natural rubber latex.

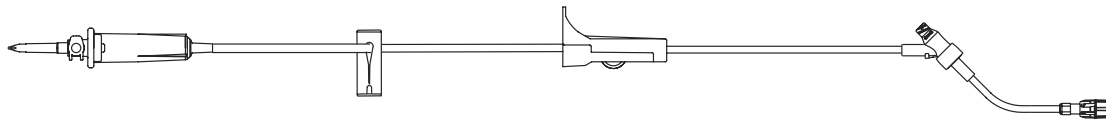

(15 drops/mL) Universal spike, integrated free-flow protector¹/slide clamp², roller clamp, CARESITE injection site 6 in. above distal end, SPIN-LOCK® connector. Priming volume: 16.8 mL, Length: 113 in. (287 cm) 354201 354201 50

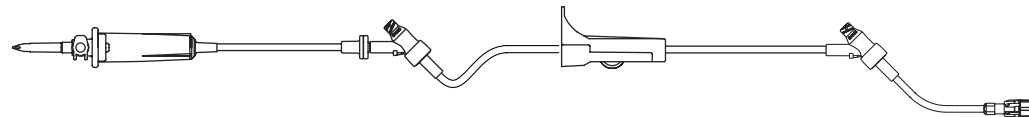

(15 drops/mL) Universal spike, backcheck valve, CARESITE valve injection sites 68 in. and 6 in. above distal end, roller clamp, SPIN-LOCK connector. Priming volume: 17 mL, Length: 84 in. (210 cm) 354202 354202 50

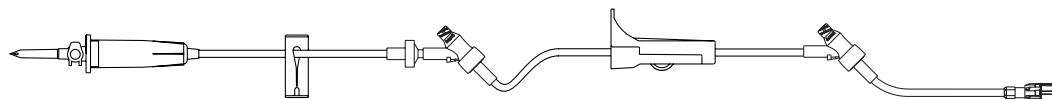

(15 drops/mL) Universal spike, slide clamp, backcheck valve, CARESITE valve injection sites 87 in. and 12 in. above distal end, roller clamp, SPIN-LOCK connector. Priming volume: 20 mL, Length: 104 in. (264 cm) 354203 354203 50

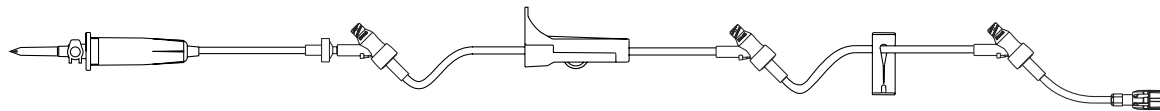

(15 drops/mL) Universal spike, backcheck valve, CARESITE valve injection sites 85 in., 41 in. and 6 in. above distal end, roller clamp, slide clamp, SPIN-LOCK connector. Priming volume: 20 mL, Length: 112 in. (285 cm) 354205 354205 50

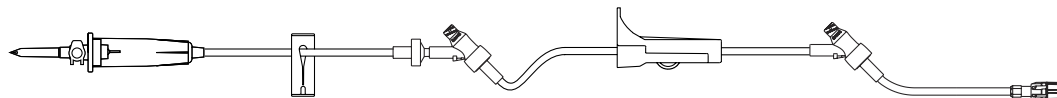

(60 drops/mL) Universal spike, slide clamp, backcheck valve, CARESITE valve injection sites 87 in. and 12 in. above distal end, roller clamp, SPIN-LOCK connector. Priming volume: 19 mL, Length: 103 in. (262 cm) 354204 354204 50

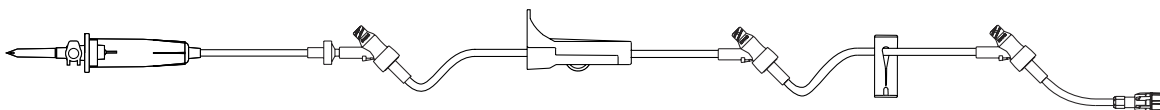

(60 drops/mL) Universal spike, backcheck valve, CARESITE valve injection sites 61 in., 26 in. and 6 in. above distal end, roller clamp, slide clamp, SPIN-LOCK connector. Priming volume: 17 mL, Length: 88 in. (223.5 cm) 354206 354206 50

CARESITE® (LAD) System

Description	Product Code	REF Number	Units Per cs
-------------	--------------	------------	--------------

Blood Sets with CARESITE Injection Sites

Components on this page do not contain natural rubber latex.

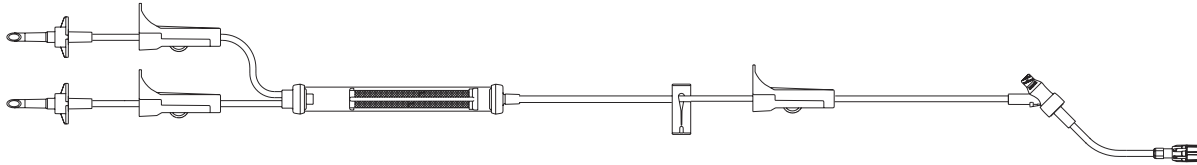

(10 drops/mL) Blood set, Y-type, non-vented spikes, two upper roller clamps, drip chamber with 170 micron blood filter, integrated free-flow protector ¹ /slide clamp ² , roller clamp, CARESITE valve injection site 6 in. above distal end, SPIN-LOCK® connector. Priming volume: 31 mL Length: 112 in. (284.5 cm)	354217	354217	50
--	--------	--------	----

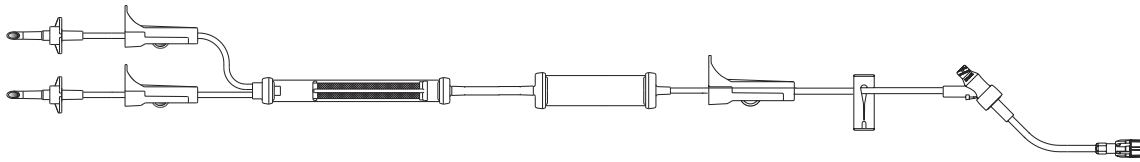

(10 drops/mL) Y-Type blood set with hand pump, 170 micron filter, CARESITE valve injection site 6 in. above distal end, roller clamp, slide clamp, SPIN-LOCK connector. Priming volume: 72 mL Length: 86 in. (218.4 cm)	354218	354218	50
---	--------	--------	----

Add-on Burette Set without Automatic Shutoff with CARESITE Valve

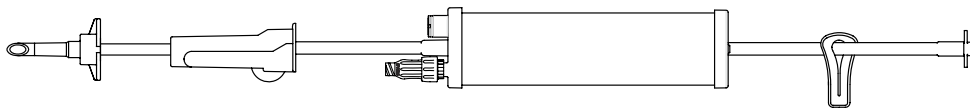

Non-vented spike, roller clamp, 150 mL burette chamber without automatic shutoff with CARESITE valve, slide clamp, spike adapter. Priming volume: 3.0 mL Length: 20 in. (51.0 cm)	470118	470118	20
---	--------	--------	----

Burette Administration Set with Automatic Shutoff and CARESITE Injection Sites

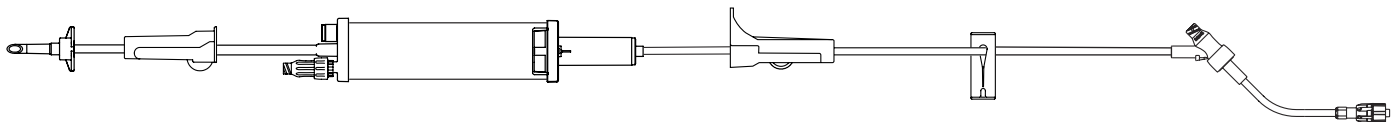

(60 drops/mL) Non-vented spike, roller clamp, 150 mL burette chamber with CARESITE valve, roller clamp, slide clamp, ULTRASITE injection site 6 in. above distal end, SPIN-LOCK connector. Priming volume: 16.0 mL Length: 88 in. (223.5 cm)		470116	20
--	--	--------	----

Needleless Products

NEEDLELESS PRODUCTS

ULTRASITE® Valve Needleless System

Description	Product Code	REF Number	Units Per cs
-------------	--------------	------------	--------------

ULTRASITE Valves

Components on this page do not contain DEHP or natural rubber latex.

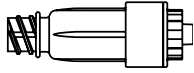

ULTRASITE valve for aspiration, injection or gravity flow of fluid upon insertion of a male luer fitting. 300 psi pressure rated. Priming volume: 0.35 mL.

CSU100 415110 100

ULTRASITE Ag antibacterial valve for aspiration, injection or gravity flow of fluid upon insertion of a male luer fitting. 45 psi pressure rated. Priming volume: 0.35 mL.

415119 415119 200

Dispensing Pins with ULTRASITE Valve

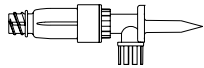

MINI-SPIKE® Dispensing Pin with ULTRASITE valve for rubber-stoppered vials. Two-way valve for aspiration or injection. Utilizes a bacterial retentive air-venting filter.

US50 412026 50

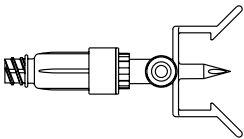

MINI-SPIKE Dispensing Pin with ULTRASITE valve and security clip. For attachment to standard 20mm rubber-stoppered vials. Two-way valve for aspiration or injection. Utilizes a bacterial retentive air-venting filter.

DP1800SC 413504 50

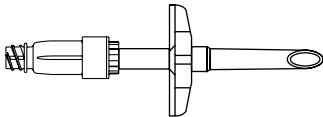

Non-vented dispensing pin with ULTRASITE valve. Two-way valve for aspiration or injection.

US10 412027 50

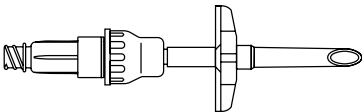

Non-vented dispensing pin with One-Way Valve and ULTRASITE® valve. For aspiration of medication from inverted bags or semi-rigid plastic containers.

DPO4000L 412023 50

Accessories for ULTRASITE Valve



Luer slip adapter. Provides a secure connection between a male luer slip connector and the ULTRASITE valve.

CSC1 654499 100

ULTRASITE® Valve Needleless System

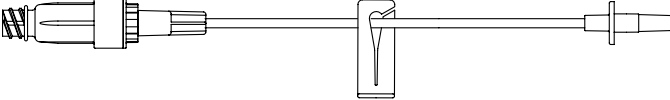
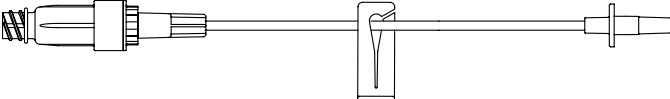
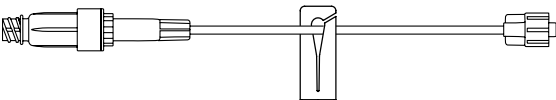
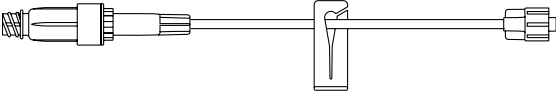
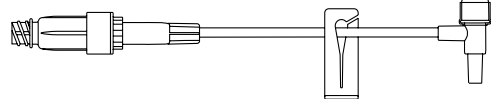
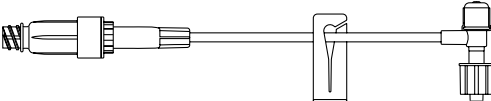
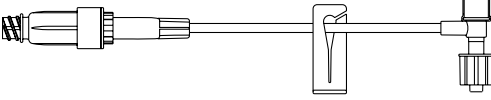
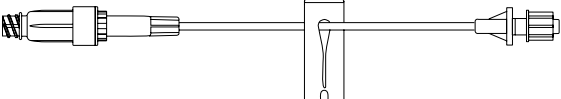
Description	Product Code	REF Number	Units Per cs
Small Bore Extension Sets with ULTRASITE Injection Site			
Components on this page do not contain DEHP or natural rubber latex.			
	CSE6S	473437	100
Small bore extension set with removable ULTRASITE valve, removable slide clamp, male luer slip connector. Priming volume: 0.5 mL, Length: 8 in. (20 cm)			
	CSE6SB	473446	100
Small bore extension set with bonded ULTRASITE valve, removable slide clamp, male luer slip connector. Priming volume: 0.5 mL, Length: 8 in. (20 cm)			
	CSE6L	473438	100
Small bore extension set with ULTRASITE valve, removable slide clamp, male luer lock connector. Priming volume: 0.6 mL, Length: 8 in. (20 cm)			
	CSE6LB	473448	100
Small bore extension set with bonded ULTRASITE valve, removable slide clamp, male luer lock connector. Priming volume: 0.6 mL, Length: 8 in. (20 cm)			
	CSE6TS	473440	100
Small bore T-port extension set with ULTRASITE valve, removable slide clamp, luer slip connector. Priming volume: 0.68 mL, Length: 5 in. (12.7 cm)			
	CSE6TSL	473439	100
Small bore T-port extension set with ULTRASITE valve, removable slide clamp, SPIN-LOCK® connector. Priming volume: 0.66 mL, Length: 5.5 in. (14.0 cm)			
	CSE6TSLB	473449	100
Small bore T-port extension set with bonded ULTRASITE valve, removable slide clamp, SPIN-LOCK connector. Priming volume: 0.66 mL, Length: 5.5 in. (14.0 cm)			
	ET08USB	470011	50
Small bore extension set with bonded ULTRASITE valve, non-removable slide clamp, SPIN-LOCK connector. Priming volume: 0.7 mL, Length: 8 in. (20 cm)			



Needleless Products

NEEDLELESS PRODUCTS

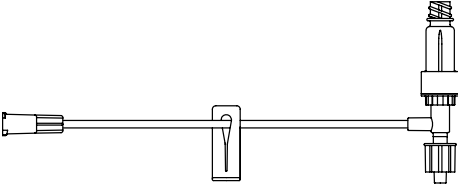
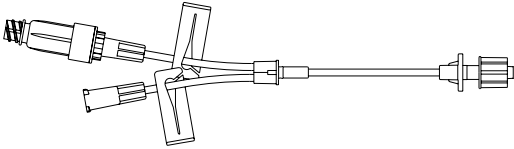
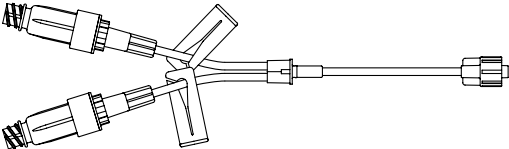
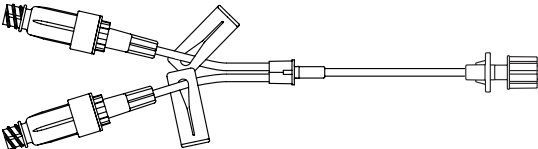
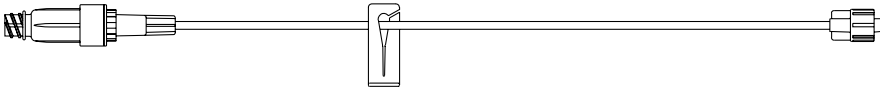
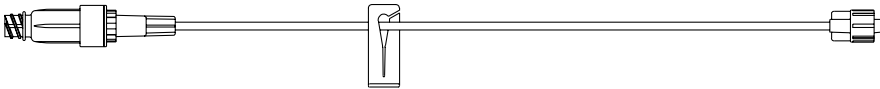
ULTRASITE® Valve Needleless System

Description	Product Code	REF Number	Units Per cs
Small Bore Extension Sets with ULTRASITE Injection Site (continued)			
Components on this page do not contain DEHP or natural rubber latex.			
	US04TL	474515	100
<p>Small Bore T-port extension set with ULTRASITE valve, slide clamp, SPIN-LOCK® connector. Priming volume: 0.6 mL, Length: 5 in. (13 cm)</p>			
	CSE6YSL	473442	100
<p>Small bore Y-extension set with removable ULTRASITE valve, removable slide clamps, SPIN-LOCK connector. Priming volume: 0.5 mL, Length: 7 in. (18 cm)</p>			
	US9027	474517	50
<p>Small bore Y-extension set with two removable ULTRASITE valves, removable slide clamps, luer lock connector. Priming volume: 1 mL, Length: 7 in. (18 cm)</p>			
	ET07US	470021	50
<p>Small bore Y-extension set with two bonded ULTRASITE valves, two slide clamps, SPIN-LOCK connector. Priming volume: 0.9 mL, Length: 7 in. (18 cm)</p>			
	CSE12L	473441	100
<p>Small bore extension set with removable ULTRASITE valve, removable slide clamp, luer lock connector. Priming volume: 0.7 mL, Length: 14 in. (36 cm)</p>			
	CSE12LB	473445	100
<p>Small bore extension set with bonded ULTRASITE valve, removable slide clamp, luer lock connector. Priming volume: 0.5 mL, Length: 14 in. (36 cm)</p>			

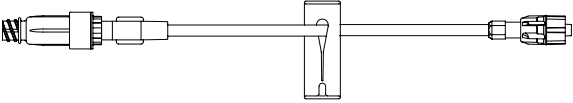
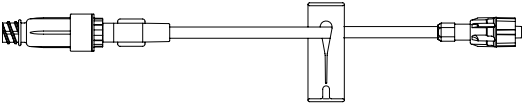
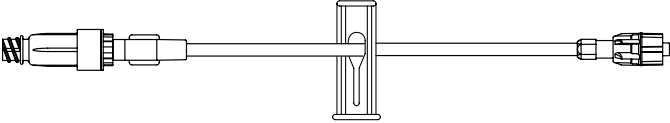
ULTRASITE® Valve Needleless System

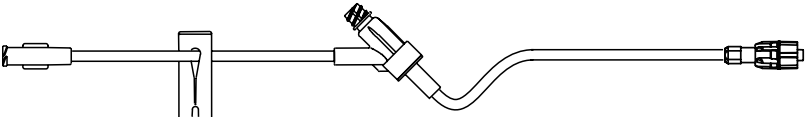
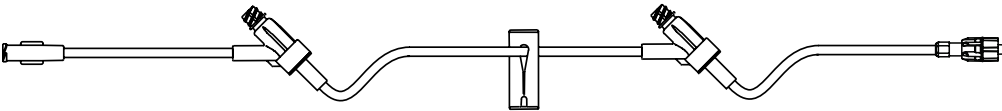
Description	Product Code	REF Number	Units Per cs
Standard Bore Extension Sets with ULTRASITE Injection Site			
	CSE8SL	473444	100
<p>Standard bore extension set with ULTRASITE valve, non-removable slide clamp, SPIN-LOCK® connector. Components do not contain DEHP or natural rubber latex. Priming volume: 0.7 mL, Length: 6.5 in. (17 cm)</p>			
	CSE8SLB	473447	100
<p>Standard bore extension set with bonded ULTRASITE valve, non-removable slide clamp, SPIN-LOCK connector. Components do not contain DEHP or natural rubber latex. Priming volume: 1.0 mL, Length: 6 in. (15 cm)</p>			
	US1320	474921	50
<p>Extension set with bonded ULTRASITE valve, kink-resistant tubing, non-removable slide clamp, SPIN-LOCK connector. Components do not contain natural rubber latex. Priming volume: 0.7 mL, Length: 7 in. (18 cm)</p>			
	CSE8TSL	473443	100
<p>Standard bore T-port extension set with ULTRASITE valve, non-removable slide clamp, SPIN-LOCK® connector. Components do not contain DEHP or natural rubber latex. Priming volume: 1.3 mL, Length: 7.5 in. (18.8 cm)</p>			
	US9060	474580	50
<p>Standard bore extension set with non-removable slide clamp, ULTRASITE valve injection site, SPIN-LOCK® connector. Components do not contain DEHP or natural rubber latex. Priming volume: 1.5 mL, Length: 8 in. (20 cm)</p>			
	CSE33SL	473436	50
<p>Standard bore extension set with two ULTRASITE valve injection sites 28 in. and 6 in. above distal end, non-removable slide clamp, SPIN-LOCK connector. Components do not contain DEHP or natural rubber latex. Priming volume: 5.4 mL, Length: 35 in. (89 cm)</p>			

Needleless Products

ULTRASITE® Valve Needleless System

Description	Product Code	REF Number	Units Per cs
-------------	--------------	------------	--------------

Filterflow® Filtered Extension Sets with ULTRASITE Injection Sites

Components on this page do not contain DEHP or natural rubber latex.

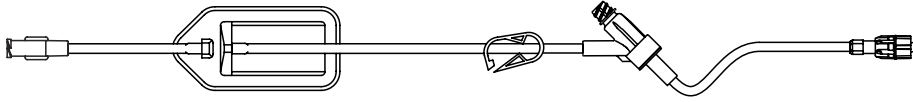

0.2 micron filter, ULTRASITE valve injection site 6 in. above distal end, on/off clamp, SPIN-LOCK® connector. US1380F 473992 50
Priming volume: 5.2 mL, Length: 16 in. (40.6 cm)

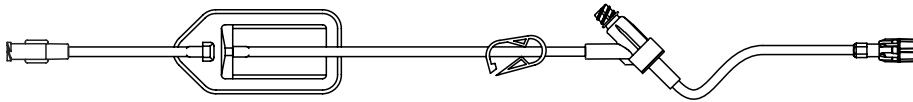

1.2 micron filter, ULTRASITE valve injection site 6 in. above distal end, on/off clamp, SPIN-LOCK connector. US1385F 473997 50
Priming volume: 4.5 mL, Length: 16 in. (40.6 cm)

Filterflow Low Volume Filtered Extension Sets with ULTRASITE Injection Sites

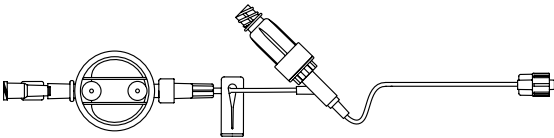

Female luer connector, 1.2 micron low volume SUPOR filter with female luer connection, slide clamp, ULTRASITE injection site 3 in. above distal end, male luer lock connector. US1207PF 474000 50
Priming volume: 0.9 mL, Length: 9 in. (22.9 cm)

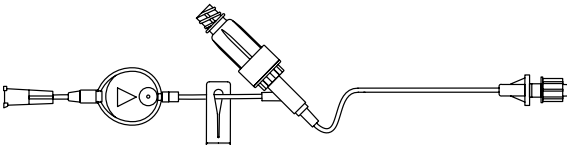

Female luer connector, 0.2 micron micro volume SUPOR filter, non-removable slide clamp, ULTRASITE valve injection site 3 inches above distal end, SPIN-LOCK connector. US2007MF 473999 50
Priming Volume: 0.7 mL, Length: 7 in. (18 cm).

SUPOR is a registered trademark of Pall Corporation

ULTRASITE® Valve Needleless System

Description	Product Code	REF Number	Units Per cs
-------------	--------------	------------	--------------

Gravity IV Administration Sets with ULTRASITE Injection Sites

Components on this page do not contain DEHP or natural rubber latex.

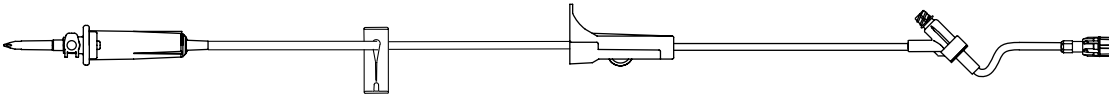

(15 drops/mL) Universal spike, slide clamp, roller clamp, ULTRASITE injection site
6 in. above distal end, SPIN-LOCK® connector.
Priming volume: 20 mL, Length: 111 in. (282 cm)

US8800*

352337*

50

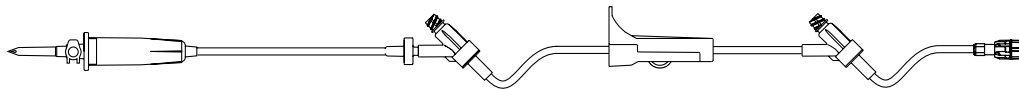

(15 drops/mL) Universal spike, backcheck valve, ULTRASITE valve injection sites
68 in. and 6 in. above distal end, roller clamp, SPIN-LOCK connector.
Priming volume: 15 mL, Length: 84 in. (210 cm)

AD1584V2USL

375090

50

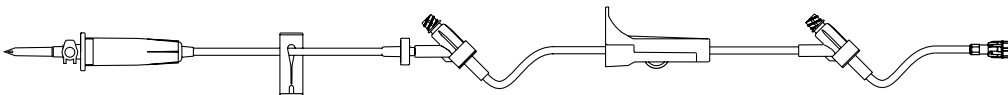

(15 drops/mL) Universal spike, slide clamp, backcheck valve, ULTRASITE valve injection sites
87 in. and 12 in. above distal end, roller clamp, SPIN-LOCK connector.
Compatible with VISTA® basic Pump. Priming volume: 20 mL, Length: 104 in. (264 cm)

CSP152VSL*

352049*

50

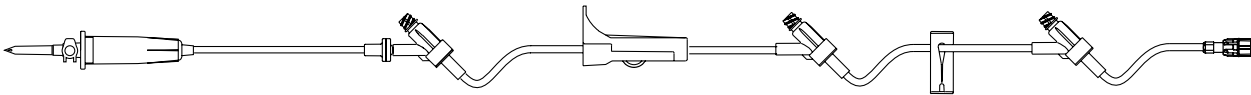

(15 drops/mL) Universal spike, backcheck valve, ULTRASITE valve injection sites
85 in., 41 in. and 6 in. above distal end, roller clamp, slide clamp, SPIN-LOCK connector.
Priming volume: 20 mL, Length: 112 in. (285 cm)

US1250*

375100*

50

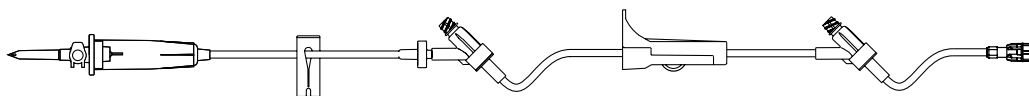

(60 drops/mL) Universal spike, slide clamp, backcheck valve, ULTRASITE valve injection sites
87 in. and 12 in. above distal end, roller clamp, SPIN-LOCK connector.
Priming volume: 19 mL, Length: 103 in. (262 cm)

CSP602VSL*

CSP602VSL*

50

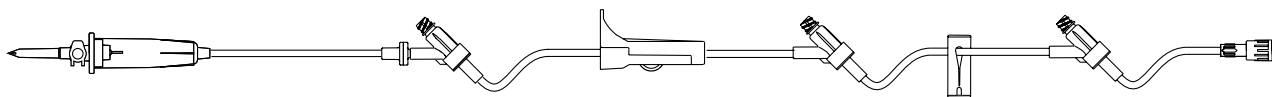

(60 drops/mL) Universal spike, backcheck valve, ULTRASITE valve injection sites
61 in., 26 in. and 6 in. above distal end, roller clamp, slide clamp, SPIN-LOCK connector.
Priming volume: 17 mL, Length: 88 in. (223.5 cm)

US1290

375101

50

* Compatible with VISTA® basic Pump

ULTRASITE® Valve Needleless System

Description	Product Code	REF Number	Units Per cs
-------------	--------------	------------	--------------

Filterflow® Filtered Administration Sets with ULTRASITE Injection Sites

Components on this page do not contain DEHP or natural rubber latex.

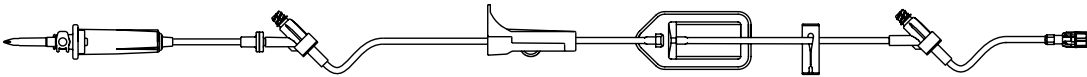

(15 drops/mL) Universal spike, backcheck valve, ULTRASITE injection sites 87 in. and 6 in. above distal end, slide clamp, roller clamp, 0.2 micron filter, slide clamp, SPIN-LOCK® connector. US8801F 352437 50
Priming volume: 21.2 mL, Length: 104 in. (264.2 cm)

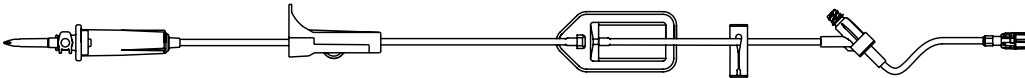

(15 drops/mL) Universal spike, integrated free-flow protector¹/slide clamp², roller clamp, 1.2 micron filter, slide clamp, ULTRASITE injection site 6 in. above distal end, SPIN-LOCK connector. US8812F US8812F 50
Priming volume: 18.9 mL, Length 91 in. (231.1cm)

Emergency Medical Services Sets with ULTRASITE Injection Sites

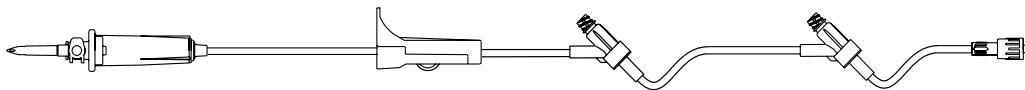

(15 drops/mL) Universal spike, roller clamp, ULTRASITE valve injection sites 8 in. and 3 in. above distal end, SPIN-LOCK connector. Priming volume: 16 mL, Length: 86 in. (218 cm) US1150 US1150 50

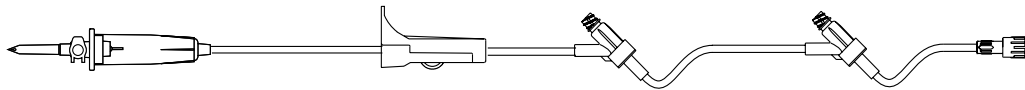

(60 drops/mL) Universal spike, roller clamp, ULTRASITE valve injection sites 8 in. and 3 in. above distal end, SPIN-LOCK connector. Priming volume: 14 mL, Length: 86 in. (218 cm) US1155 352379A 50

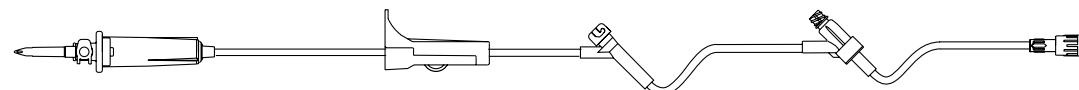

(15 drops/mL) Universal spike, roller clamp, SAFELINE® injection site 8 in. above distal end, ULTRASITE valve injection site 3 in. above distal end, SPIN-LOCK connector. US1160 US1160 50
Priming volume: 15 mL, Length: 86 in. (218.4 cm)

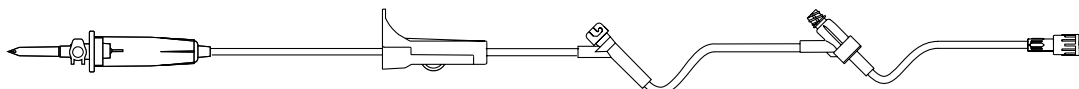

(60 drops/mL) Universal spike, roller clamp, SAFELINE injection site 8 in. above distal end, ULTRASITE valve injection site 3 in. above distal end, SPIN-LOCK connector. US1165 352237 50
Priming volume: 15 mL, Length: 86 in. (218.4 cm)

ULTRASITE® Valve Needleless System

Description	Product Code	REF Number	Units Per cs
-------------	--------------	------------	--------------

Blood Sets with ULTRASITE Injection Sites

Components on this page do not contain natural rubber latex.

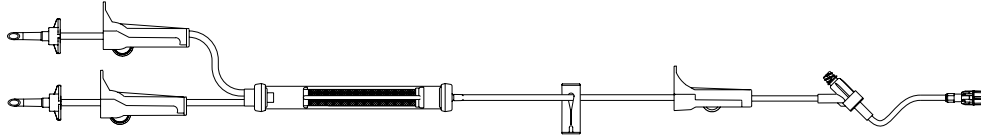

(10 drops/mL) Blood set, Y-type, non-vented spikes, two upper roller clamps, drip chamber with 170 micron blood filter, slide clamp, roller clamp, ULTRASITE valve injection site 6 in. above distal end, SPIN-LOCK® connector. Priming volume: 31 mL Length: 112 in. (284.5 cm)

US8850* US8850* 50

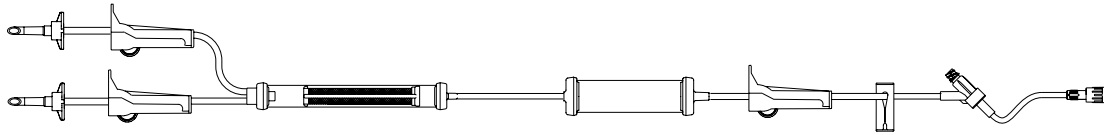

(10 drops/mL) Y-Type blood set with hand pump, 170 micron filter, ULTRASITE valve injection site 6 in. above distal end, roller clamp, slide clamp, SPIN-LOCK connector. Priming volume: 72 mL Length: 86 in. (218 cm)

US5145 375154 50

Add-on Burette Set without Automatic Shutoff with ULTRASITE Valve

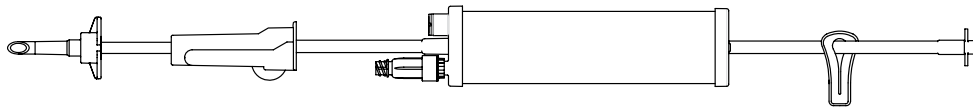

Non-vented spike, roller clamp, 150 mL burette chamber without automatic shutoff with ULTRASITE valve, slide clamp, spike adapter. Priming volume: 3.0 mL Length: 20 in. (51.0 cm)

375111 375111 20

Add-on Burette Set with Automatic Shutoff with ULTRASITE Valve

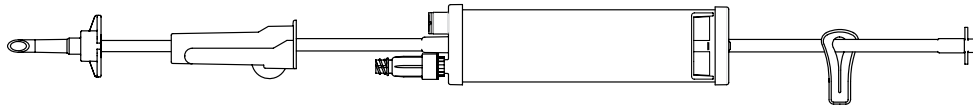

Non-vented spike, roller clamp, 150 mL burette chamber with ULTRASITE valve, slide clamp, spike adapter. Priming volume: 3.0 mL Length: 20 in. (51 cm)

375059 375059 20

Burette Administration Set with Automatic Shutoff and ULTRASITE Injection Sites

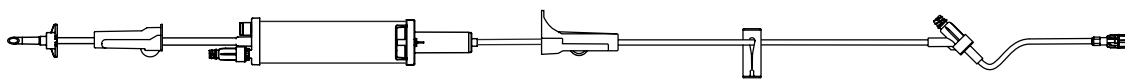

(60 drops/mL) Non-vented spike, roller clamp, 150 mL burette chamber with ULTRASITE valve, roller clamp, slide clamp, ULTRASITE injection site 6 in. above distal end, SPIN-LOCK connector. Priming volume: 16.0 mL Length: 88 in. (223.5 cm)

US1540M 375137 20

* Compatible with VISTA® basic Pump

Needleless Products

ULTRASITE® Valve Needleless System

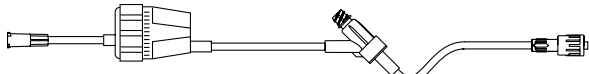
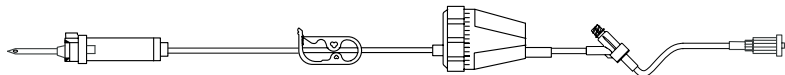
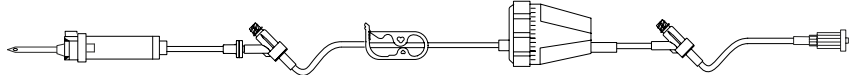
Description	Product Code	REF Number	Units Per cs
Rate Flow® Regulator Set with ULTRASITE Injection Sites			
Components on this page do not contain DEHP or natural rubber latex.			
	US5300	US5300	50
Female adapter, Rate Flow Regulator, ULTRASITE valve injection site 6 in. above distal end, SPIN-LOCK connector. Priming volume: 2.6 mL, Length: 18 in. (46 cm)			
	US5322	375152	50
(20 drops/mL) Universal spike, on/off clamp, Rate Flow Regulator, ULTRASITE valve injection site 6 in. above distal end, SPIN-LOCK connector. Priming volume: 16.3 mL, Length: 83.66 in. (212.5 cm)			
	US5932	375153	50
(20 drops/mL) Universal spike, backcheck valve, on/off clamp, Rate Flow Regulator, 2 ULTRASITE valve injection sites 70 in. and 6 in. above the distal end, SPIN-LOCK connector. Priming volume: 18 mL, Length: 90.16 in. (229 cm)			

Accessories for ULTRASITE valve

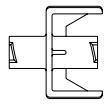
	CSC1	654499	100
Luer slip adapter. Provides a secure connection between a male luer slip connector and the ULTRASITE valve.			
	FDC1000	415080	100
Fluid dispensing connector - proximal and distal female luer lock connector. Used for pre-filling unit dose syringes from a large master syringe (color - green). Allows for the transfer of blood from a collecting syringe to a Vacutainer® tube without the use of a needle.			

* for injection only

SAFELINE® Needleless System

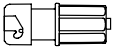
Description	Product Code	REF Number	Units Per cs
SAFELINE Needleless Split Septum Injection Site			
 SAFELINE split septum injection site, male luer lock connector. Components do not contain DEHP or natural rubber latex. Priming volume: 0.25 mL	NF9100	NF9100	400

Extension Sets with SAFELINE Split Septum Injection Sites

 SAFELINE split septum injection site, removable slide clamp, microbore tubing, male luer lock connector. Components do not contain natural rubber latex. Priming volume: 0.42 mL, Length: 7 in. (17.8 cm)	NF1310	NF1310	50
--	--------	--------	----

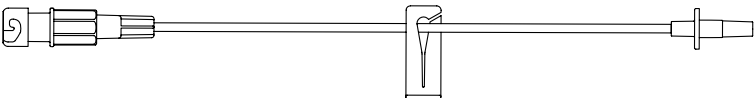
 SAFELINE split septum injection site, removable slide clamp, microbore tubing, male luer slip connector. Components do not contain natural rubber latex. Priming volume: 0.40 mL, Length: 7 in. (17.8 cm)	NF1312	NF1312	50
--	--------	--------	----

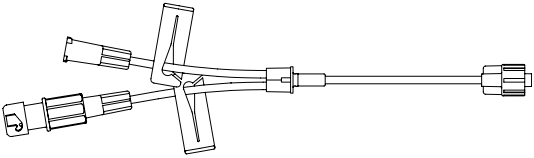
 Y-type small bore extension set with attached SAFELINE split septum injection site, female adapter, two removable slide clamps, male luer lock connector. Components do not contain DEHP or natural rubber latex. Priming volume: 0.58 mL, Length: 7 in. (17.8 cm)	NF1318	NF1318	100
--	--------	--------	-----

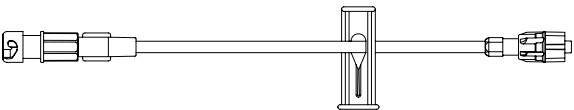
 Small bore extension set with SAFELINE split septum injection site, kink-resistant tubing, removable slide clamp, SPIN-LOCK® connector. Components do not contain natural rubber latex. Priming volume: 0.63 mL, Length: 7 in. (17.8 cm)	NF1320	NF1320	50
---	--------	--------	----

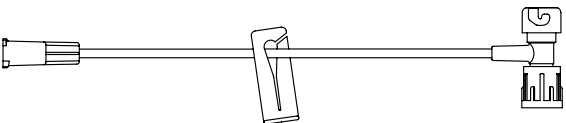
 Female adapter, microbore tubing, removable slide clamp, T-connector with SAFELINE split septum injection site., SPIN-LOCK® connector. Components do not contain DEHP or natural rubber latex. Priming volume: 0.3 mL, Length: 6 in. (15.2 cm)	NF1330	NF1330	50
---	--------	--------	----

Needleless Products

SAFELINE® Needleless System

Description	Product Code	REF Number	Units Per cs
-------------	--------------	------------	--------------

Extension Sets with SAFELINE Split Septum Injection Sites (continued)

Components on this page do not contain DEHP or natural rubber latex.

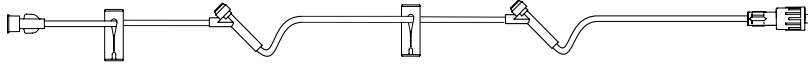

Female adapter, large bore tubing, slide clamp, SAFELINE split septum injection sites 28 in. and 6 in. above distal end, slide clamp, SPIN-LOCK® connector. Priming volume: 6.0 mL, Length: 35 in. (89 cm)	NF1370	NF1370	50
--	--------	--------	----

Filterflow® Filtered Add-on Extension Set with SAFELINE Split Septum Injection Site

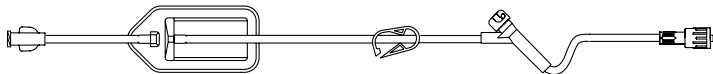

Female luer lock, 0.2 micron filter, SAFELINE split septum injection site 6 in. above distal end, on/off clamp, SPIN-LOCK connector. Priming volume: 5.3 mL, Length 16 in. (41 cm)	NF1380F	473993	50
--	---------	--------	----

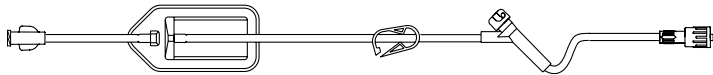

Female luer lock, 1.2 micron filter, SAFELINE split septum injection site 6 in. above distal end, on/off clamp, SPIN-LOCK connector. Priming volume: 5.1 mL, Length 16 in. (40.0 cm)	NF1385F	473998	50
--	---------	--------	----

Basic Administration Sets with SAFELINE Split Septum Injection Site

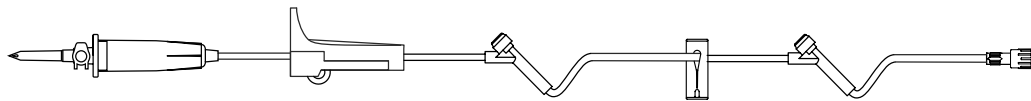

(15 drops/mL) Universal spike, roller clamp, SAFELINE split septum injection sites 40 in. and 6 in. above distal end, slide clamp, SPIN-LOCK connector. Priming volume: 19.0 mL, Length: 90 in. (228 cm)	NF1150	NF1150	50
--	--------	--------	----

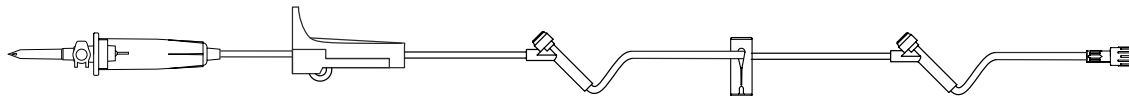

(60 drops/mL) Universal spike, roller clamp, SAFELINE split septum injection sites 38 in. and 6 in. above distal end, slide clamp, SPIN-LOCK connector. Priming volume: 18 mL, Length: 94 in. (239 cm)	NF1190	NF1190	50
--	--------	--------	----

Secondary Set for use with SAFELINE Split Septum Injection Site



(15 drops/mL) Universal spike, roller clamp, SPIN-LOCK connector, SAFELINE Clip Lock® cannula, plastic bag hanger. Priming volume: 10 mL, Length: 49 in. (125 cm)		NF1430	50
---	--	--------	----

SAFELINE® Needleless System

Description	Product Code	REF Number	Units Per cs
-------------	--------------	------------	--------------

ADDitIV® Primary Administration Sets with Backcheck Valve and SAFELINE Split Septum Injection Sites

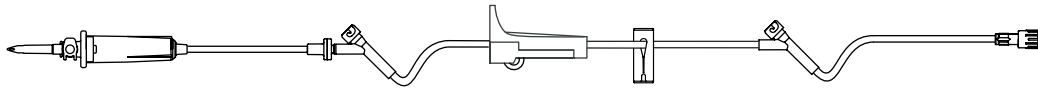

(15 drops/mL) Universal spike, backcheck valve, SAFELINE split septum injection sites 80 in. and 6 in. above distal end, roller clamp, SPIN-LOCK® connector. Components do not contain DEHP or natural rubber latex. Priming volume: 19 mL, Length: 104 in. (264 cm)

NF1585	352604	50
--------	--------	----

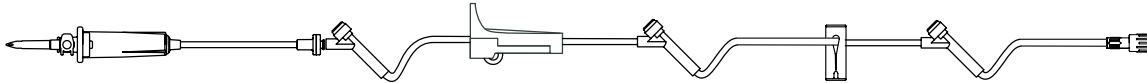

(15 drops/mL) Universal spike, backcheck valve, SAFELINE split septum injection sites 88 in., 30 in. and 6 in. above distal end, roller clamp, slide clamp, SPIN-LOCK connector. Components do not contain DEHP or natural rubber latex. Priming volume: 20 mL, Length: 111 in. (282 cm)

NF1251	NF1251	50
--------	--------	----

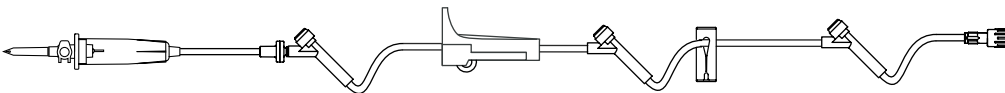

60 drops/mL) Universal spike, backcheck valve, SAFELINE split septum injection sites 62 in., 27 in. and 6 in. above distal end, roller clamp, slide clamp, SPIN-LOCK connector. Components do not contain DEHP or natural rubber latex. Priming volume: 17 mL, Length: 88 in. (223.5 cm)

NF1290	NF1290	50
--------	--------	----

Blood Administration Sets with SAFELINE Split Septum Injection Site

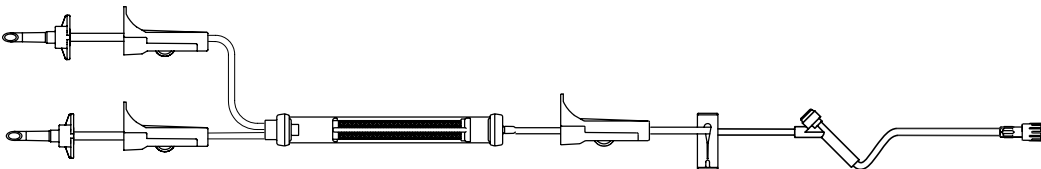

(10 drops/mL) Y-type, non-vented spikes, drip chamber with 170 micron blood filter, three roller clamps, slide clamp, SAFELINE split septum injection site 6 in. above distal end, SPIN-LOCK connector. Components do not contain natural rubber latex. Priming volume: 34 mL, Length: 84 in. (213 cm)

NF5140	NF5140	50
--------	--------	----

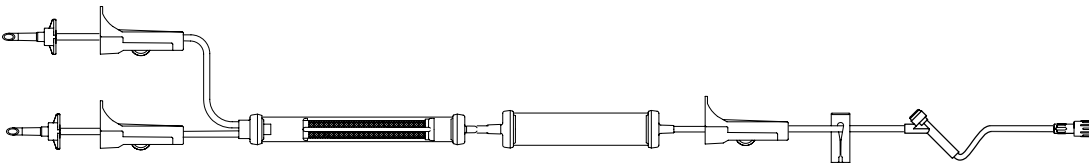

(10 drops/mL) Y-type, non-vented spikes, drip chamber with 170 micron blood filter, pump chamber, three roller clamps, slide clamp, SAFELINE split septum injection site 6 in. above distal end, SPIN-LOCK connector. Components do not contain natural rubber latex. Priming volume: 72 mL, Length: 86 in. (218 cm)

NF5145	NF5145	50
--------	--------	----

SAFELINE® Needleless System

Description	Code	Number	Per cs
-------------	------	--------	--------

Filterflow® Filtered Gravity Administration Sets with SAFELINE Split Septum Injection Sites

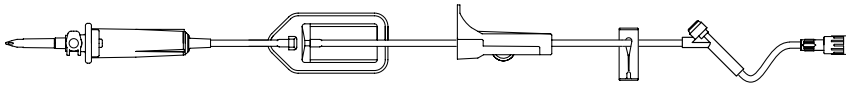

(15 drops/mL) Universal spike, 0.2 micron filter, SAFELINE split septum injection site 6 in. above distal end, SPIN-LOCK® connector. Components do not contain DEHP or natural rubber latex. Priming volume: 21.0 mL, Length: 89 in. (226 cm)

NF1225F

352434

50

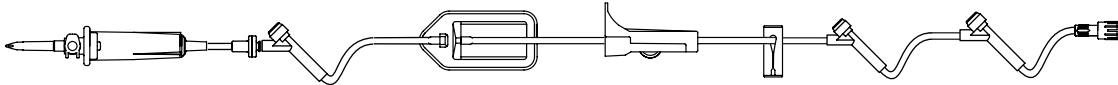

(15 drops/mL) Universal spike, 0.2 micron filter, backcheck valve, SAFELINE split septum injection sites 84 in., 26 in. and 6 in. above distal end, SPIN-LOCK connector. Components do not contain DEHP or natural rubber latex. Priming volume: 21 mL, Length: 111 in. (281.9 cm)

NF1210F

NF1210F

50

Extension Set with Rate Flow® Regulator and SAFELINE Split Septum Injection Site

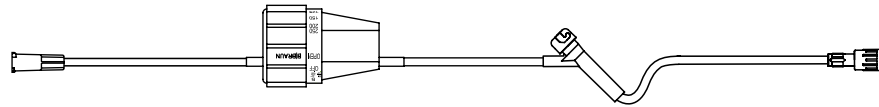

Female adapter, Rate Flow Regulator, SAFELINE split septum injection site 6 in. above distal end, SPIN-LOCK connector. Components do not contain DEHP or natural rubber latex. Priming volume: 2.6 mL, Length: 18 in. (46 cm)

NF5300

NF5300

50

ADDitIV® Primary Administration Set with Backcheck Valve and Rate Flow® Regulator and SAFELINE Split Septum Injection Sites

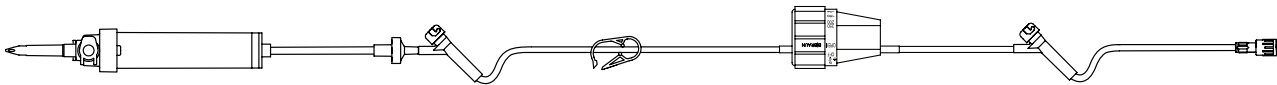

(20 drops/mL) Universal spike, 15 micron filter, backcheck valve, Rate Flow Regulator, SAFELINE split septum injection sites 54 in. and 6 in. above distal end, SPIN-LOCK connector. Components do not contain DEHP or natural rubber latex. Priming volume: 18 mL, Length: 90.16 in. (229 cm)

NF5932

NF5932

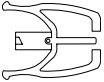
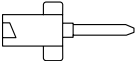
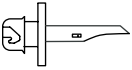
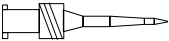

50

SAFELINE® Needleless System

Description	Product Code	REF Number	Units Per cs
Accessories for SAFELINE Split Septum Injection Site			
Components on this page do not contain DEHP or natural rubber latex.			
			
SAFELINE Clip Lock® cannula; locking cannula with female luer.	NF9200	NF9200	400
			
SAFELINE Blunt Cannula; blunt cannula with female luer.	NF9210	NF9210	400
			
SAFELINE multidose vial adapter.	NF9280	NF9280	100
			
Medic® plastic anti-stick needle/connector.	NF9285	NF9285	500

CYTOGUARD™ Closed Luer Connector

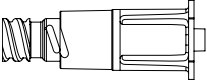
Components on this page do not contain DEHP or natural rubber latex.

			
CYTOGUARD Closed Luer Connector. Priming volume 0.1 mL	456081	456081	100
			
CYTOGUARD Cap. Dust cover cap for use with CYTOGUARD Closed Luer Connector	456082	456082	200

Medic is a registered trademark of Medisystems Corporation

EPIDURAL NEEDLES AND CATHETERS

Description	Product Code	REF Number	Units Per Cs
PERIFIX® Epidural Needles			
NEW 17 Ga. x 2 in. (50 mm) Tuohy Needle - non-winged and clear hub	E1720TN	332191	25
17 Ga. x 3½ in. (90 mm) Tuohy Needle - with wings and clear hub	E1735T	332180	25
17 Ga. x 3½ in. (90 mm) Dull Decade Series Tuohy Needle - with Weiss Wings	E1735W	332164	25
17 Ga. x 4 in. (100 mm) Tuohy Needle - with wings and clear hub	E1740T	332188	25
17 Ga. x 4½ in. (115 mm) Tuohy Needle - with wings and clear hub	E1745T	332181	25
18 Ga. x 2 in. (50 mm) Tuohy Needle - with wings and clear hub	E1820TN	332172	25
18 Ga. x 3½ in. (90 mm) Tuohy Needle - with wings and clear hub	E1835T	332166	25
18 Ga. x 3½ in. (90 mm) Hustead Needle - with wings and clear hub	E1835H	332165	25
18 Ga. x 4 in. (100 mm) Tuohy Needle - with wings and clear hub	E1840T	332187	25
18 Ga. x 4¾ in. (120 mm) Tuohy Needle - with wings and clear hub	E18475T	332186	25
18 Ga. x 6 in. (150 mm) Tuohy Needle - with wings and clear hub	E1860T	332160	25
NEW 20 Ga. x 2 in. (50 mm) Tuohy Needle - with wings and clear hub	E2020T	332178	25
20 Ga. x 3½ in. (90 mm) Tuohy Needle - with wings and clear hub	E2035T	332168	25
20 Ga. x 3½ in. (90 mm) Tuohy Needle - non-winged and clear hub	E2035TN	332167	25
20 Ga. x 4 in. (100 mm) Tuohy Needle - with wings and clear hub	E2040T	332189	25
NEW 20 Ga. x 6 in. (150 mm) Tuohy Needle - with wings and clear hub	E2060T	332193	25
22 Ga. x 2 in. (50 mm) Tuohy Needle - non-winged and clear hub	E2220TN	332173	25
22 Ga. x 3.15 in. (80 mm) Tuohy Needle - with wings and clear hub	E2230T	332171	25
EPICAN™ Caudal Needles			
EPICAN 20 Ga. x 2 in. (50 mm) Caudal Needle - non-winged and clear hub	E2020CN	332175	25
EPICAN 22 Ga. x 1¾ in. (35 mm) Caudal Needle - non-winged and clear hub	E22138CN	332177	25
PERIFIX FX Springwound Epidural Catheters			
19 Ga. x 36 in. (91 cm) Radiopaque Polyamide Springwound PERIFIX FX Catheter (MR unsafe) - open tip with catheter connector and threading assist guide	EC190F	333514	25
19 Ga. x 36 in. (91 cm) Radiopaque Polyamide Springwound PERIFIX FX Catheter (MR unsafe) - closed tip and three lateral side ports, with catheter connector and threading assist guide	EC19CF	333512	25
PERIFIX Epidural Catheters			
19 Ga. x 40 in. (101 cm) Polyamide PERIFIX Catheter - open tip with catheter connector and threading assist guide	EC19O	333501	25
19 Ga. x 40 in. (101 cm) Polyamide PERIFIX Catheter - closed tip and three lateral side ports, with catheter connector and threading assist guide	EC19C	333511	25
20 Ga. x 40 in. (101 cm) Polyamide PERIFIX Catheter - open tip with catheter connector and threading assist guide	EC20O	333520	25
20 Ga. x 40 in. (101 cm) Polyamide PERIFIX Catheter - closed tip and three lateral side ports, with catheter connector and threading assist guide	EC20C	333540	25
20 Ga. x 40 in. (101 cm) Polyamide Styleted PERIFIX Catheter - closed tip and three lateral side ports, with catheter connector and threading assist guide	EC20CS	333532	25
20 Ga. x 40 in. (101 cm) Polyamide PERIFIX Soft Tip Catheter - closed tip and three lateral side ports, with catheter connector and threading assist guide	EC20CST	333521	25
20 Ga. x 40 in. (101 cm) Polyamide/Polyurethane PERIFIX ONE Catheter - closed tip and six lateral side ports, with catheter connector and threading assist guide	EC20CNG	333541	25
20 Ga. x 40 in. (101 cm) Polyamide/Polyurethane PERIFIX ONE Pediatric Catheter - closed tip and six lateral side ports, with catheter connector and threading assist guide	EC20CPNG	333539	25
24 Ga. x 28 in. (72 cm) Polyamide/Polyurethane PERIFIX ONE Pediatric Catheter - closed tip and six lateral side ports, with catheter connector and threading assist guide	EC24CPNG	333538	25

Description	Product Code	REF Number	Units Per Cs
Connectors for Epidural Catheters			
PERIFIX® Catheter Connector – for use with PERIFIX 19 Ga. epidural catheters	PCC1900	332285	50
PERIFIX Catheter Connector – for use with PERIFIX 20 Ga. to 24 Ga. epidural catheters	PCC2000	332283	50
Filter for Epidural Catheters			
PERIFIX 0.2 µm Flat Epidural Filter – for use with all PERIFIX catheters and PERIFIX PinPad	FEF100	415000	25
PERIFIX PinPad – securement device for PERIFIX 0.2 µm Flat Epidural Filter	FPP100	415004	25
Glass Loss-of-Resistance Syringes			
5 mL Glass – Luer Lock, Metal Tip	GLR5ML	332155	10
5 mL Glass – Luer Slip, Metal Tip	GLR5MS	332156	10
10 mL Glass – Luer Lock, Metal Tip	GLR10ML	332157	10
10 mL Glass – Luer Slip, Metal Tip	GLR10MS	332158	10
PERIFIX Plastic Loss-of-Resistance Syringes			
8 mL Plastic – Luer Slip	PLR10S	332150	50
8 mL Plastic – Luer Lock	PLR10L	332152	50
PERIFIX FX Springwound Continuous Epidural Sets – 17 Ga. Needle			
17 Ga. x 3½ in. (90 mm) Winged Tuohy Needle Set with 19 Ga. Springwound open tip catheter (MR unsafe), catheter connector and threading assist guide	CE17TF	332234	12
17 Ga. x 3½ in. (90 mm) Winged Tuohy Needle Set with 19 Ga. Springwound closed tip catheter (MR unsafe), catheter connector and threading assist guide	CE17TFC	332238	12
PERIFIX Continuous Epidural Sets – 17 Ga. Needle			
17 Ga. x 3½ in. (90 mm) Tuohy Needle Set with 20 Ga. closed tip catheter, catheter connector and threading assist guide	CE17T	332202	12
17 Ga. x 3½ in. (90 mm) Tuohy Needle Set with 19 Ga. open tip catheter, catheter connector and threading assist guide	CE17TO	332204	12
PERIFIX Continuous Epidural Sets – 18 Ga. Needle			
18 Ga. x 3½ in. (90 mm) Tuohy Needle Set with 20 Ga. closed tip catheter, catheter connector and threading assist guide	CE18T	332200	12
18 Ga. x 3½ in. (90 mm) Hustead Needle Set with 20 Ga. closed tip catheter, catheter connector and threading assist guide	CE18H	332210	12
18 Ga. x 3½ in. (90 mm) Tuohy Needle Set with 20 Ga. open tip catheter, catheter connector, threading assist guide and intermittent injection cap	CE18TIN	332201	12
NEW PERIFIX ONE Epidural Set			
18 Ga. x 3½ in. (90 mm) Tuohy Needle Set with 20 Ga. Polyamide/Polyurethane PERIFIX ONE Catheter – closed tip and six lateral side ports, with catheter connector and threading assist guide	CE18TO	332294	12
PERIFIX ONE Pediatric Epidural Sets			
18 Ga. x 2 in. (50 mm) Tuohy Needle Set with 20 Ga. Polyamide/Polyurethane PERIFIX ONE Pediatric Catheter – closed tip and six lateral side ports, with catheter connector and threading assist guide	CEP18TO	332291	12
20 Ga. x 2 in. (50 mm) Tuohy Needle Set with 24 Ga. Polyamide/Polyurethane PERIFIX ONE Pediatric Catheter – closed tip and six lateral side ports, with catheter connector and threading assist guide	CEP20TO	332293	12

SINGLE DOSE EPIDURAL TRAYS

PERIFIX® Single Dose Epidural Trays PERIFIX Single Dose Safety Epidural Trays

Tray Components

PROCEDURAL NEEDLES - EPIDURAL

	SD17TD	SD18TB	SD18TD	SD18HD	SD18TK	SD18TDP	SD18TDCD	SD20TDPL	SD20TDPS	SD20TD	SD22TD
PERIFIX 17 Ga. x 3 1/2 in. (90 mm) Tuohy, Winged	●										
PERIFIX 18 Ga. x 3 1/2 in. (90 mm) Tuohy, Winged		●	●		●	●	●				
PERIFIX 18 Ga. x 3 1/2 in. (90 mm) Hustead, Winged				●							
PERIFIX 20 Ga. x 3 1/2 in. (90 mm) Tuohy, Metal Stylet, Winged								●	●	●	
PERIFIX 22 Ga. x 3 in. (80 mm) Tuohy, Metal Stylet, Winged											●

HYPODERMIC NEEDLES

25 Ga. x 1 1/2 in.	●			●	●		●	●	●	●	●
27 Ga. x 1 1/4 in.								●	●		
25 Ga. x 1 in. SafetyGlide™											
25 Ga. x 5/8 in.		●	●			●					
22 Ga. x 1 1/2 in. SafetyGlide™											
22 Ga. x 1 1/2 in.		●	●			●		●	●		
18 Ga. x 1 1/2 in. SafetyGlide™											
3 mL Plastic Luer Lock Syringe with Pre-Attached 18 Ga. x 1 1/2 in. Needle	●	●	●	●	●	●	●	●	●	●	●

LOSS-OF-RESISTANCE SYRINGES

5 mL Glass - Luer Lock, Metal Tip	●	●	●	●	●		●			●	●
PERIFIX 8 mL Plastic - Luer Slip						●			●		
PERIFIX 8 mL Plastic - Luer Lock								●			

SYRINGES

1 mL Plastic - Luer Slip								●	●		
3 mL Plastic - Luer Lock											
10 mL Plastic - Luer Lock							●	●	●		
20 mL Plastic - Luer Lock	●	●	●	●	●	●		●	●	●	●

PROCEDURAL DRUGS

Lidocaine HCl (1%), 5 mL (skin wheal)	●		●	●	●	●	●	●	●	●	●
Lidocaine HCl (1.5%) with Epi, 5 mL (test dose)					●						

DILUENT/LOSS OF RESISTANCE

Sodium Chloride (0.9%), 10 mL	●		●	●	●	●	●	●	●	●	●
-------------------------------	---	--	---	---	---	---	---	---	---	---	---

DRAPE

Drape, Clear Plastic, 4 in. Fenestrated, 30 in. x 24 in.	●	●	●	●	●	●	●	●	●	●	●
Drape, Blue, 4 in. Fenestrated, 30 in. x 24 in.						●					

PREP ITEMS/OTHER

Packet Povidone-Iodine Solution	●	●	●	●	●	●	●	●	●	●	●
Prep Sponges (3 per tray)	●	●	●	●	●	●	●	●	●	●	●
Needle Block Foam with Holder							●	●	●		
NeedleVISE®				●							
MP1000 MICRO PIN® Dispensing Pin											
Filter Straw® Particulate Matter Filter	●	●	●	●	●	●	●	●	●	●	●
4 in. x 4 in. Gauze Sponges (4 per tray)	●	●	●	●	●	●	●	●	●	●	●
Paper Towel, 3 Ply	●	●	●	●	●	●	●	●	●	●	●
Drug Identification Label Set	●	●	●	●	●	●	●	●	●	●	●

SAFETY ENGINEERED TRAY

Product Code	Reorder No.	SD18TDY	332252
SD17TD	332248		
SD18TB	332250		
SD18TD	332251		
SD18HD	332249		
SD18TK	332256		
SD18TDP	332247		
SD18TDCD	332232		
SD20TDPL	332258		
SD20TDPS	332259		
SD20TD	332254		
SD22TD	332255		
SD18TDY			332252

All Trays: 10 Units/Case

SafetyGlide is a trademark of Becton Dickinson and Company
NeedleVISE is a registered trademark of Atrion Medical Products, Inc.

PERIFIX® Continuous Epidural Trays with
17 Ga. Epidural Needle

PERIFIX Continuous Safety Epidural Tray with
17 Ga. Epidural Needle

Tray Components

	Product Code	Reorder No.
PROCEDURAL NEEDLES - EPIDURAL		
PERIFIX 17 Ga. x 3 1/2 in. (90 mm) Tuohy, Winged	CE17TKF	332086
PERIFIX 17 Ga. x 4 in. (100 mm) Tuohy, Winged	CE17TKFPS	332087
HYPODERMIC NEEDLES		
27 Ga. x 1 1/4 in.	CE17TBFC	332077
25 Ga. x 1 1/2 in.	CE17TKFCS	332078
25 Ga. x 1 in. SafetyGlide™	CE17TKFC	332079
25 Ga. x 5/8 in.	CE17TKFSA	332080
22 Ga. x 1 1/2 in. SafetyGlide™	CE17TKFCS	332097
22 Ga. x 1 1/2 in.	CE17TKFS	332098
18 Ga. x 1 1/2 in.		
18 Ga. x 1 1/2 in. SafetyGlide™		
3 mL Plastic Luer Lock Syringe with Pre-Attached 18 Ga. x 1 1/2 in. Needle		
3 mL Plastic Luer Lock Syringe with Pre-Attached 25 Ga. x 1 1/2 in. Needle		
LOSS-OF-RESISTANCE SYRINGES		
5 mL Glass - Luer Slip, Metal Tip		
5 mL Glass - Luer Lock, Metal Tip		
PERIFIX 8 mL Plastic - Luer Slip		
SYRINGES		
1 mL Plastic - Luer Slip		
3 mL Plastic - Luer Lock		
10 mL Plastic - Luer Slip		
20 mL Plastic - Luer Lock		
EPIDURAL CATHETERS *		
PERIFIX FX 19 Ga. Springwound, Open Tip (MR unsafe)		
PERIFIX FX 19 Ga. Springwound, Closed Tip (MR unsafe)		
PERIFIX 19 Ga. Closed Tip		
PERIFIX 20 Ga. Closed Tip		
PERIFIX 20 Ga. Open Tip		
PERIFIX 20 Ga. Soft Tip, Closed Tip		
PROCEDURAL DRUGS		
Lidocaine HCl (1%), 5 mL (skin wheal)		
Lidocaine HCl (1.5%) with Epi, 5 mL (test dose)		
DILUENT/LOSS OF RESISTANCE		
Sodium Chloride (0.9%), 10 mL		
DRAPES		
Drape, Blue, Non-Fenestrated		
Drape, Blue, 4 in. Fenestrated, 30 in. x 24 in.		
Drape, Clear plastic, 4 in. fenestrated, 30 in. x 24 in.		
PREP ITEMS/OTHER		
Packet Povidone-Iodine Solution		
Prep Sponges (3 per tray)		
DuraPrep® Solution		
PERIFIX 0.2 µm Flat Epidural Filter		
PERIFIX PinPad (securement device for PERIFIX 0.2 µm Flat Epidural Filter)		
Catheter Support Pad		
Tegaderm® 4 in. x 4 3/4 in. Dressing		
Needle Block Foam with Holder		
NeedleVISE®		
Female Luer Lock Connector (converts Luer Lock to Luer Slip)		
MP1000 MICRO PIN® Dispensing Pin		
Filter Straw® Particulate Matter Filter		
Paper Towel, 3 Ply		
4 in. x 4 in. Gauze Sponges (4 per tray)		
Drug Identification Label Set		

	Product Code	Reorder No.
	CE17TB	332224
	CE17TOD	332235
	CE17TK	332221
	CE17TKPS	332233
	CE17TKCD	332229
	CE17TKDLS	332212
	CE17TKST	332082
	CE17TB19C	332242
	CE17TK19CDP	332262
	CE17TKFCY	332075

SAFETY ENGINEERED TRAY

* All catheters packaged with thread assist guide and connector.

All trays: 10 Units/Case

SafetyGlide is a trademark of Becton Dickinson and Company
DuraPrep and Tegaderm are registered trademarks of 3M
NeedleVISE is a registered trademark of Atrion Medical Products, Inc.

CONTINUOUS EPIDURAL TRAYS (18 Ga.)

PERIFIX® Continuous Epidural Trays with 18 Ga. Epidural Needle

PERIFIX Continuous Safety Epidural Tray with 18 Ga. Epidural Needle

Tray Components

	Product Code	Reorder No.
PROCEDURAL NEEDLES - EPIDURAL		
PERIFIX 18 Ga. x 3½ in. (90 mm) Tuohy, Winged	CE18TB	332222
PERIFIX 18 Ga. x 3½ in. (90 mm) Hustead, Winged	CE18TBPS	332239
HYPODERMIC NEEDLES		
27 Ga. x 1¼ in.	CE18HB	332223
25 Ga. x 1½ in.	CE18HK	332230
25 Ga. x 1 in. SafetyGlide™	CE18HKCD	332206
25 Ga. x 5⁄8 in.	CCE18HK10L	332264
22 Ga. x 1½ in. SafetyGlide™	CE18HKST	332084
22 Ga. x 1½ in.	CE18HKPS	332231
18 Ga. x 1½ in. SafetyGlide™	CE18TBLS	332219
3 mL Plastic Luer Lock Syringe with Pre-Attached 18 Ga. x 1½ in. Needle	CE18TOD	332236
LOSS-OF-RESISTANCE SYRINGES		
5 mL Glass - Luer Slip, Metal Tip	CE18TK	332220
5 mL Glass - Luer Lock, Metal Tip	CE18TKPS	332216
PERIFIX 8 mL Plastic - Luer Slip	CE18TKCD	332211
10 mL Glass - Luer Lock, Metal Tip	CE18TKCDLS	332209
SYRINGES		
3 mL Plastic - Luer Lock	CE18TKCD10L	332217
20 mL Plastic - Luer Lock	CE18TKST	332081
EPIDURAL CATHETERS *		
PERIFIX 20 Ga. Closed Tip	CE18TKDP	332215
PERIFIX 20 Ga. Open Tip	CE18TKO	332282
PERIFIX 20 Ga. Soft Tip, Closed Tip		
PERIFIX ONE 20 Ga. Closed Tip (with six lateral sideports)		
PROCEDURAL DRUGS		
Lidocaine HCl (1%), 5 mL (skin wheal)		
Lidocaine HCl (1.5%) with Epi, 5 mL (test dose)		
DILUENT/LOSS OF RESISTANCE		
Sodium Chloride (0.9%), 10 mL		
DRAPES		
Drape, Blue, Non-Fenestrated		
Drape, Blue, 4 in. Fenestrated, 30 in. x 24 in.		
Drape, Clear plastic, 4 in. Fenestrated, 30 in. x 24 in.		
PREP ITEMS/OTHER		
Packet Povidone-Iodine Solution		
Prep Sponges (3 per tray)		
DuraPrep® Solution		
PERIFIX 0.2 µm Flat Epidural Filter		
PERIFIX PinPad (securement device for PERIFIX 0.2 µm Flat Epidural Filter)		
Catheter Support Pad		
Tegaderm® 4 in. x 4¾ in. Dressing		
Needle Block Foam with Holder		
NeedleVISE®		
MP1000 MICRO PIN® Dispensing Pin		
Filter Straw® Particulate Matter Filter		
Paper Towel, 3 Ply		
4 in. x 4 in. Gauze Sponges (4 per tray)		
Drug Identification Label Set		

* All catheters packaged with thread assist guide and connector.

All trays: 10 Units/Case

SafetyGlide is a trademark of Becton Dickinson and Company
 DuraPrep and Tegaderm are registered trademarks of 3M
 NeedleVISE is a registered trademark of Atrion Medical Products, Inc.

PERIFIX® ONE Pediatric Epidural Trays

Tray Components

PROCEDURAL NEEDLES - EPIDURAL

PERIFIX 18 Ga. x 2 in. (50 mm) Tuohy, Winged

PERIFIX 20 Ga. x 2 in. (50 mm) Tuohy, Winged

HYPODERMIC NEEDLES

25 Ga. x 1 1/2 in.

3 mL Plastic Luer Lock Syringe with Pre-Attached 18 Ga. x 1 1/2 in. Needle

LOSS-OF-RESISTANCE SYRINGE

5 mL Glass - Luer Slip, Metal Tip

SYRINGE

20 mL Plastic - Luer Lock

EPIDURAL CATHETERS *

PERIFIX ONE 20 Ga. Closed Tip (with six lateral sideports)

PERIFIX ONE 24 Ga. Closed Tip (with six lateral sideports)

PROCEDURAL DRUG

Lidocaine HCl (1.5%) with Epi, 5 mL (test dose)

DILUENT/LOSS OF RESISTANCE

Sodium Chloride (0.9%), 10 mL

DRAPE

Drape, Clear Plastic, 4 in. Fenestrated, 15 in. x 15 in.

PREP ITEMS/OTHER

Packet Povidone-Iodine Solution

Prep Sponges (3 per tray)

PERIFIX 0.2 µm Flat Epidural Filter

Catheter Support Pad

Benzoin Swab Stick

Tegaderm® 4 in. x 4 3/4 in. Dressing

Filter Straw® Particulate Matter Filter

Paper Towel, 3 Ply

4 in. x 4 in. Gauze Sponges (4 per tray)

Drug Identification Label Set

Reorder No.

332290
332292

Product Code

CEP18TKO
CEP20TKO

* All catheters packaged with thread assist guide and connector. All trays: 10 Units/Case

Description	Product Code	REF Number	Units Per Cs
-------------	--------------	------------	--------------

ESPOCAN® Combined Spinal/Epidural Anesthesia Sets

17 Ga. x 3 1/2 in. (90 mm) Tuohy Needle with backeye lumen and PENCAN® 25 Ga. x 5 in. (130 mm) Pencil Point Needle with centering sleeve and 5 mL clear syringe.	ES1725	333161	12
18 Ga. x 3 1/2 in. (90 mm) Tuohy Needle with backeye lumen and PENCAN 27 Ga. x 5 1/2 in. (140 mm) Pencil Point Needle with centering sleeve, ESPOCAN® Docking System and 5 mL clear syringe.	ES1827DS	333174	12
18 Ga. x 3 1/2 in. (90 mm) Tuohy Needle with backeye lumen and PENCAN 27 Ga. x 5 in. (130 mm) Pencil Point Needle with centering sleeve and 5 mL clear syringe.	ES1827	333160	12
18 Ga. x 3 1/2 in. (90 mm) Tuohy Needle with backeye lumen and SPINOCAN® 27 Ga. x 5 in. (130 mm) Needle with centering sleeve and 5 mL clear syringe.	ES1827Q	333180	12

ESPOCAN® and Non-ESPOCAN Combined Spinal/Epidural Trays

Tray Components

	Product Code	Reorder No.
	ES1725K	333165
	ES1725KFX	333196
	NES1727KFX	333197
	ES1827K	333192
	ES1827OK	333182
	ES1827KDS	333194
	ES1827KO	333193 NEW
PROCEDURAL NEEDLES - EPIDURAL		
PERIFIX® 17 Ga. x 3½ in. (90 mm) Tuohy, Winged		
ESPOCAN 17 Ga. x 3½ in. (90 mm) Tuohy, Winged		
ESPOCAN 18 Ga. x 3½ in. (90 mm) Tuohy, Winged		
PROCEDURAL NEEDLES - SPINAL		
SPINOCAN® 27 Ga. x 5 in. (130 mm) with Centering Sleeve		
PENCAN® 25 Ga. x 5 in. (130 mm) with Centering Sleeve		
PENCAN 27 Ga. x 5 in. (130 mm) with Centering Sleeve		
PENCAN 27 Ga. x 5 in. (130 mm) without Centering Sleeve		
PENCAN 27 Ga. x 5½ in. (140 mm) with Centering Sleeve		
HYPODERMIC NEEDLES		
27 Ga. x 1¼ in.		
25 Ga. x 1½ in.		
25 Ga. x 5⁄8 in.		
22 Ga. x 1½ in.		
3 mL Plastic Luer Lock Syringe with Pre-Attached 18 Ga. x 1½ in. Needle		
LOSS-OF-RESISTANCE SYRINGES		
5 mL Glass - Luer Slip, metal tip		
5 mL Glass - Luer Lock, metal tip		
SYRINGES		
1 mL Plastic - Luer Slip		
3 mL Plastic - Luer Slip		
5 mL Plastic - Luer Slip		
20 mL Plastic - Luer Lock		
EPIDURAL CATHETERS *		
PERIFIX FX 19 Ga. Springwound, Open Tip (MR unsafe)		
PERIFIX FX 19 Ga. Springwound, Closed Tip (MR unsafe)		
PERIFIX 20 Ga. Closed Tip		
PERIFIX 20 Ga. Soft Tip, Closed Tip		
PERIFIX ONE 20 Ga. Closed Tip		
PROCEDURAL DRUGS		
Lidocaine HCl (1%), 5 mL (Skin Wheel)		
Lidocaine HCl (1.5%) with Epi, 5 mL (Test Dose)		
DILUENT/LOSS OF RESISTANCE		
Sodium Chloride (0.9%), 10 mL		
DRAPE		
Drape, Clear Plastic, 4 in. Fenestrated, 30 in. x 24 in.		
PREP ITEMS/OTHER		
Packet Povidone-Iodine Solution		
Prep Sponges (3 per tray)		
PERIFIX 0.2 µm Flat Epidural Filter		
PERIFIX PinPad (securement device for PERIFIX 0.2 µm Flat Epidural Filter)		
Catheter Support Pad		
Needle Block Foam with Holder		
ESPOCAN Docking System		
Filter Straw® Particulate Matter Filter		
Paper Towel, 3 Ply		
4 in. x 4 in. Gauze Sponges (4 per tray)		
Drug Identification Label Set		

* All catheters packaged with thread assist guide and connector

All trays: 10 Units/Case

Description	Product Code	REF Number	Units Per cs
Pencil Point Needles			
PENCAN® Pencil Point Spinal Needles			
PENCAN 22 Ga. x 3½ in. (90 mm)	P2235	333866	25
PENCAN 24 Ga. x 4 in. (100 mm) with 20 Ga. Introducer	P2440	333884	25
PENCAN 25 Ga. x 1 in. (25 mm)	P2510	333878	25
PENCAN 25 Ga. x 2 in. (50 mm)	P2520	333880	25
PENCAN 25 Ga. x 3½ in. (90 mm)	P2535	333853	25
PENCAN 25 Ga. x 5 in. (130 mm)	P25127	333875	25
PENCAN 25 Ga. x 6.1 in. (156 mm)	P25155	333877	25
PENCAN 27 Ga. x 3½ in. (90 mm)	P2735	333873	25
PENCAN 27 Ga. x 5 in. (130 mm)	P27127	333876	25
Quincke Bevel Needles			
SPINOCAN® Spinal Needles with Quincke Bevel			
SPINOCAN 18 Ga. x 3½ in. (90 mm)	S1835	333350	50
SPINOCAN 20 Ga. x 3½ in. (90 mm)	S2035	333335	50
SPINOCAN 22 Ga. x 1½ in. (40 mm)	S2215	333325	50
SPINOCAN 22 Ga. x 3½ in. (90 mm)	S2235	333320	50
SPINOCAN 22 Ga. x 4¾ in. (120 mm)	S22475	333315	50
SPINOCAN 22 Ga. x 5 in. (130 mm)	S22127	333355	50
SPINOCAN 22 Ga. x 7 in. (180 mm)	S22178	333357	50
SPINOCAN 25 Ga. x 3½ in. (90 mm)	S2535	333313	50
SPINOCAN 25 Ga. x 4¾ in. (120 mm)	S25475	333308	50
SPINOCAN 26 Ga. x 3½ in. (90 mm)	S2635	333300	50
SPINOCAN 27 Ga. x 3½ in. (90 mm)	S2735	333290	50
Introducer Needle			
20 Ga. x 1⅜ in. (35 mm) - for use with 25, 26, and 27 Ga. Spinal Needles	SI2000	333370	50
Spinal Procedural Syringe			
5 mL Glass—Luer Slip	GS5MS	332147	10

SPROTTE is a registered trademark of Pajunk GmbH

SPINAL TRAYS

PENCAN® SPINAL Trays
 SPROTTE® SPINAL Trays
 PENCAN Safety SPINAL Trays

	Product Code	Reorder No.																	
Tray Components																			
PROCEDURAL NEEDLES - SPINAL																			
Pencan 24 Ga. x 4 in. (100 mm)	P24BK	333868	●	●	●	●													
Pencan 25 Ga. x 3½ in. (90 mm)	P24BKDP	333867																	
Pencan 27 Ga. x 3½ in. (90 mm)	P24LK	333870																	
	P24LBK	333869	●	●	●	●													
	P25K	333858																	
	P25SK	333855																	
	P25BK	333851																	
	P25BKDP	333862																	
	P25LK	333852																	
	P25LBK	333863																	
	P27BK	333871																	
	P27LK	333872																	
INTRODUCER NEEDLES																			
20 Ga. x 1¼ in. TW Introducer																			
20 Ga. x 1⅜ in. Introducer			●	●	●	●													
21 Ga. x 1.18 in. Introducer																			
HYPODERMIC NEEDLES																			
25 Ga. x 1½ in.			●	●	●	●	●	●	●	●	●	●	●	●	●	●	●	●	●
25 Ga. x 1 in. SafetyGlide™																			
25 Ga. x 5⁄8 in.																			
22 Ga. x 1½ in. SafetyGlide™																			
22 Ga. x 1½ in.																			
18 Ga. x 1½ in. SafetyGlide™																			
3 mL Plastic Luer Lock Syringe with Pre-Attached 18 Ga. x 1½ in.			●	●	●	●	●	●	●	●	●	●	●	●	●	●	●	●	●
SYRINGES																			
3 mL Plastic Luer Lock Syringe with Pre-Attached Filter Straw®																			
5 mL Plastic - Luer Slip			●	●	●	●	●	●	●	●	●	●	●	●	●	●	●	●	●
PROCEDURAL DRUGS																			
Epinephrine 0.1%, 1 mL			●	●	●	●													
Bupivacaine 0.75% with Dextrose 8.25%, 2 mL			●	●															
Lidocaine HCl 5% with Dextrose 7.5%, 2 mL																			
Lidocaine HCl 1%, 5 mL (skin wheal)			●	●	●	●													
DRAPE																			
Drape, Clear Plastic, 4 in. Fenestrated, 30 in. x 24 in.			●	●	●	●	●	●	●	●	●	●	●	●	●	●	●	●	●
PREP ITEMS/OTHER																			
Packet Povidone-Iodine Solution			●		●	●	●	●	●	●		●	●	●	●	●	●	●	●
Prep Sponges (3 per tray)			●		●	●	●	●	●	●		●	●	●	●	●	●	●	●
DuraPrep® Solution				●															
Needle Block Foam with Holder			●	●	●	●	●	●	●	●	●	●	●	●	●	●	●	●	●
NeedleWISE®																			
Filter Straw Particulate Matter Filter			●	●	●	●	●	●	●	●	●	●	●	●	●	●	●	●	●
Paper Towel, 3 Ply			●	●	●	●	●	●	●	●	●	●	●	●	●	●	●	●	●
4 in. x 4 in. Gauze Sponges (4 per tray)			●	●	●	●	●	●	●	●	●	●	●	●	●	●	●	●	●
Drug Identification Label Set			●	●	●	●	●	●	●	●	●	●	●	●	●	●	●	●	●

All Trays: 10 Units/Case

SafetyGlide is a trademark of Becton Dickinson and Company
 SPROTTE is a registered trademark of Pajunk GmbH
 NeedleWISE is a registered trademark of Atrion Medical Products, Inc.



Spinal Support Trays
SPINOCAN® Spinal Trays
SPINOCAN Safety Engineered SPINAL Trays

Tray Components

PROCEDURAL NEEDLES - SPINAL

	ST100	S22K	S22SK	S22BK	S22LK	S25SK	S25BK	S25LK	S26BK	S26LK
Spinocan 22 Ga. x 3 1/2 in. (90 mm)		•	•	•	•					
Spinocan 25 Ga. x 3 1/2 in. (90 mm)						•	•	•		
Spinocan 26 Ga. x 3 1/2 in. (90 mm)									•	•

INTRODUCER NEEDLES

	ST100	S22K	S22SK	S22BK	S22LK	S25SK	S25BK	S25LK	S26BK	S26LK
18 Ga. x 1 1/4 in. Introducer						•	•	•		
20 Ga. x 1 1/4 in. TW Introducer	•								•	•

HYPODERMIC NEEDLES

	ST100	S22K	S22SK	S22BK	S22LK	S25SK	S25BK	S25LK	S26BK	S26LK
25 Ga. x 1 1/2 in.	•	•	•	•	•	•	•	•	•	•
25 Ga. x 1 in. SafetyGlide™										
25 Ga. x 5/8 in.				•	•		•	•	•	•
22 Ga. x 1 1/2 in. SafetyGlide™										
22 Ga. x 1 1/2 in.		•	•	•	•	•	•	•	•	•
3 mL Plastic Luer Lock Syringe with Pre-Attached 18 Ga. x 1 1/2 in. Needle	•	•	•	•	•	•	•	•	•	•

SYRINGES

	ST100	S22K	S22SK	S22BK	S22LK	S25SK	S25BK	S25LK	S26BK	S26LK
3 mL Plastic Luer Lock Syringe with Pre-Attached Filter Straw®										
5 mL Plastic - Luer Slip	•	•	•	•	•	•	•	•	•	•

PROCEDURAL DRUGS

	ST100	S22K	S22SK	S22BK	S22LK	S25SK	S25BK	S25LK	S26BK	S26LK
Epinephrine 0.1%, 1 mL			•	•	•	•	•	•	•	•
Bupivacaine 0.75% with Dextrose 8.25%, 2 mL				•			•		•	
Lidocaine HCl 5% with Dextrose 7.5%, 2 mL					•			•		•
Lidocaine HCl 1%, 5 mL (skin wheal)	•		•	•	•	•	•	•	•	•

DRAPE

	ST100	S22K	S22SK	S22BK	S22LK	S25SK	S25BK	S25LK	S26BK	S26LK
Drape, Clear Plastic, 4 in. Fenestrated, 30 in. x 24 in.	•	•	•	•	•	•	•	•	•	•

PREP ITEMS/OTHER

	ST100	S22K	S22SK	S22BK	S22LK	S25SK	S25BK	S25LK	S26BK	S26LK
Packet Povidone-Iodine Solution	•	•	•	•	•	•	•	•	•	•
Prep Sponges (3 per tray)	•	•	•	•	•	•	•	•	•	•
Needle Block Foam with Holder	•	•	•	•	•	•	•	•	•	•
NeedleVISE®										
Filter Straw Particulate Matter Filter	•	•	•	•	•	•	•	•	•	•
Paper Towel, 3 Ply	•	•	•	•	•	•	•	•	•	•
4 in. x 4 in. Gauze Sponges (4 per tray)	•	•	•	•	•	•	•	•	•	•
Drug Identification Label Set	•	•	•	•	•	•	•	•	•	•

SAFETY ENGINEERED TRAY

Reorder No.	Product Code	333236
333400	ST100	
333235	S22K	
333234	S22SK	
333231	S22BK	
333230	S22LK	
333214	S25SK	
333211	S25BK	
333220	S25LK	
333201	S26BK	
333200	S26LK	
	S22LKAY	333236

All Trays: 10 Units/Case

SafetyGlide is a registered trademark of Becton Dickinson and Company
 NeedleVISE is a registered trademark of Atrion Medical Products, Inc.

NERVE STIMULATOR, STIMULATOR ACCESSORIES AND SINGLE SHOT NERVE BLOCK NEEDLES

Description	Product Code	REF Number	Units Per Cs
STIMUPLEX® Nerve Stimulator Products			
STIMUPLEX HNS12 Nerve Stimulator with SENSE*, with four-pin electrode connecting cable, 9V battery, testing resistor and Operation Manual in carrying case	HNS12	4892098	1
STIMUPLEX SWITCH Nerve Stimulator current selector between needle/catheter (for use with HNS11 and HNS12 only)	STIMSWITCH	333543	1
STIMUPLEX PEN Percutaneous nerve mapping device (for use with HNS11 and HNS12 only) and operation manual in carrying case	STIMPEN	333544	1
STIMUPLEX Remote Control (for use only with Stimuplex DigRC or HNS12)	RC300	333559	1
STIMUPLEX Dig RC replacement electrode connecting cable (for use with STIM300)	SEC3	333556	1
STIMUPLEX Dig electrode connecting cable with four-pin plug (for use with STIM200 only)	SEC2	333546	1
STIMUPLEX HNS11 replacement electrode connecting cable (for use with HNS11 and HNS12 only)	HEC	333576	1
STIMUPLEX® A Insulated Needles with 30° Bevel (for use with STIMUPLEX nerve stimulators)			
20 Ga. x 6 in. (150 mm) Insulated Needle with Extension Set		4894278	25
21 Ga. x 4 in. (100 mm) Insulated Needle with Extension Set		4894260	25
22 Ga. x 1 in. (25 mm) Insulated Needle with Extension Set		4894539	25
22 Ga. x 1 3/8 in. (35 mm) Insulated Needle with Extension Set		4894367	25
22 Ga. x 2 in. (50 mm) Insulated Needle with Extension Set		4894502	25
24 Ga. x 1 in. (25 mm) Insulated Needle with Extension Set		4894251	25
NEW STIMUPLEX Ultra Insulated Echogenic Needles with 30° Bevel (for use with Ultrasound and STIMUPLEX nerve stimulators)			
22 Ga. x 1 3/8 in. (35 mm) Insulated Echogenic Needle with Extension Set	STIMAU2235/30	333650	25
22 Ga. x 2 in. (50 mm) Insulated Echogenic Needle with Extension Set	STIMAU2250/30	333652	25
22 Ga. x 3 1/8 in. (80 mm) Insulated Echogenic Needle with Extension Set	STIMAU2280/30	333654	25
22 Ga. x 4 in. (100 mm) Insulated Echogenic Needle with Extension Set	STIMAU22100/30	333656	25
20 Ga. x 6 in. (150 mm) Insulated Echogenic Needle with Extension Set	STIMAU20150/30	333660	25
STIMUPLEX D Insulated Needles with 30° and 15° Bevel (for use with STIMUPLEX nerve stimulators)			
22 Ga. x 2 in. (50 mm) Insulated Needle with Extension Set, 30° Bevel	STIMD2250/30	333689	25
22 Ga. x 3 1/8 in. (80 mm) Insulated Needle with Extension Set, 15° Bevel	STIMD2280/15	333674	25
22 Ga. x 3 1/8 in. (80 mm) Insulated Needle with Extension Set, 30° Bevel	STIMD2280/30	333684	25
22 Ga. x 4 3/4 in. (120 mm) Insulated Needle with Extension Set, 15° Bevel	STIMD22120/15	333676	25
23 Ga. x 2 3/4 in. (70 mm) Insulated Needle with Extension Set, 15° Bevel	STIMD2370/15	333672	25
25 Ga. x 1 3/8 in. (35 mm) Insulated Needle with Extension Set, 15° Bevel	STIMD2535/15	333670	25
PLEXUFIX® Brachial Plexus Sets (B-Plex® Non-Insulated Needles)			
22 Ga. x 1 in. (25 mm) Needle and Extension Set, 30° Bevel	BP2210	332017	25
22 Ga. x 1 1/2 in. (40 mm) Needle and Extension Set, 45° Bevel	BP2215	332015	25
22 Ga. x 2 in. (50 mm) Needle and Extension Set, 30° Bevel	BP2220	332010	25
24 Ga. x 1 in. (25 mm) Needle and Extension Set, 30° Bevel	BP2410	332001	25
24 Ga. x 2 in. (50 mm) Needle and Extension Set, 30° Bevel	BP2420	332000	25
NEW ULTRAPLEX Non-Insulated Echogenic Needles with 30° Bevel (for use with Ultrasound)			
22 Ga. x 1 3/8 in. (35 mm) Non-Insulated Echogenic Needle with Extension Set	UPLEX2235/30	333662	25
22 Ga. x 2 in. (50 mm) Non-Insulated Echogenic Needle with Extension Set	UPLEX2250/30	333664	25
22 Ga. x 3 1/8 in. (80 mm) Non-Insulated Echogenic Needle with Extension Set	UPLEX2280/30	333666	25
20 Ga. x 4 in. (100 mm) Non-Insulated Echogenic Needle with Extension Set	UPLEX20100/30	333668	25
20 Ga. x 6 in. (150 mm) Non-Insulated Echogenic Needle with Extension Set	UPLEX20150/30	333669	25

CONTINUOUS NERVE BLOCK SETS

Description	Product Code	REF Number	Units Per Cs
NEW CONTIPLEX® C Continuous Catheter-Over-Needle Nerve Block Sets (Insulated Needle) with C-Grip (catheter visible under ultrasound)			
19 Ga. x 18.7 cm catheter OVER 25 Ga. x 19 cm needle with:			
30° bevel	CONTIPLEXC/30	333697	5
15° bevel	CONTIPLEXC	333696	5
Above sets include: One Catheter Connector, One 0.2 µm Procedural Filter, One PinPad Securement Device, One 30cm Connection Tubing			
NEW CONTIPLEX Tuohy Ultra Continuous Nerve Block Sets (Insulated Echogenic Tuohy Needle) with Non-Stimulating Catheter			
18 Ga. x 2 in. (50 mm)	CNB200TU	331673	12
18 Ga. x 4 in. (100 mm)	CNB400TU	331674	12
18 Ga. x 6 in. (150 mm)	CNB600TU	331676	12
Above sets include: One Sideport Valve Assembly with Extension Tubing, One 20 Ga. x 39 in. (100 cm) Polyamide Nylon Catheter with Closed Tip, One Catheter Connector, One Threading Assist Guide			
NEW CONTIPLEX FX Continuous Nerve Block Sets (Non-Insulated Tuohy Needle) with Non-Stimulating Springwound Catheter (catheter visible under ultrasound)			
17 Ga. x 3½ in. (80 mm), Open Tip Catheter (MR unsafe)	CNBFX3500	331670	12
17 Ga. x 3½ in. (80 mm), Closed Tip Catheter (MR unsafe)	CNBFX350C	331672	12
Above sets include: One Sideport Valve Assembly with Extension Tubing, One 19 Ga. x 36 in. (91 cm) Polyamide Springwound FX Catheter (MR unsafe), One Catheter Connector, One Threading Assist Guide			
CONTIPLEX STIM Continuous Nerve Block Sets (Insulated Tuohy Needle) with Stimulating Catheter (catheter visible under ultrasound)			
18 Ga. x 2 in. (50 mm)	SCNB2	331757	10
18 Ga. x 4 in. (100 mm)	SCNB4	331758	10
Above sets include: One Sideport Valve Assembly with Extension Tubing, One 20 Ga. Stimulating Catheter with Integrated Wire (MR unsafe), One Catheter Connector, One 0.2 µm Procedural Filter, One Threading Assist Guide			
CONTIPLEX® Tuohy Continuous Nerve Block Sets (Insulated Tuohy Needle) with Non-Stimulating Catheter			
18 Ga. x 1½ in (40 mm)	CNB150	331695	12
18 Ga. x 2 in. (50 mm)	CNB200T	331691	12
18 Ga. x 4 in. (100 mm)	CNB400	331693	12
18 Ga. x 6 in. (150 mm)	CNB600	331694	12
Above sets include: One Sideport Valve Assembly with Extension Tubing, One 20 Ga. x 39 in. (100 cm) Polyamide Nylon Catheter with Closed Tip, One Catheter Connector, One Threading Assist Guide			
CONTIPLEX Straight Continuous Nerve Block Sets (Insulated Needle) with Non-Stimulating Catheter			
18 Ga. x 2 in. (50 mm)	CNB200S	331697	12
18 Ga. x 4 in. (100 mm)	CNB400S	331698	12
18 Ga. x 6 in. (150 mm)	CNB600S	331690	12
Above sets include: One Sideport Valve Assembly with Extension Tubing, One 20 Ga. x 39 in. (100 cm) Polyamide Nylon Catheter with Closed Tip, One Catheter Connector, One Threading Assist Guide			

CONTINUOUS NERVE BLOCK SETS AND SUPPORT TRAYS

Description	Product Code	REF Number	Units Per Cs
CONTIPLEX D Continuous Nerve Block Sets (Catheter over Insulated Needle) with Non-Stimulating Catheter			
22 Ga. x 2 1/8 in (55 mm), 15° Bevel	CNB2055D	331686	12
1 - 20 Ga. x 2 1/8 in. Cannula Introducer over 22 Ga. Short Bevel Insulated Introducer Needle 1 - 24 Ga. Polyamide Styleted Nylon Catheter with Open Tip 1 - Catheter Connector 1 - Threading Assist Guide			
20 Ga. x 2 1/8 in. (55 mm), 15° Bevel	CNB200D/15	331680	12
20 Ga. x 2 1/8 in. (55 mm), 30° Bevel	CNB200D/30	331685	12
CNB200D/15 and CNB200D/30 contain: 1 - 18 Ga. x 2 1/8 in. Cannula Introducer over 20 Ga. Short Bevel Insulated Introducer Needle 1 - 20 Ga. Polyamide Nylon Catheter with Open Tip 1 - Catheter Connector 1 - Threading Assist Guide			
20 Ga. x 4 3/8 in. (110 mm), 15° Bevel	CNB400D/15	331687	12
1 - 18 Ga. x 4 3/8 in. Cannula Introducer over 20 Ga. Short Bevel Insulated Introducer Needle 1 - 20 Ga. Polyamide Nylon Catheter with Open Tip 1 - Catheter Connector 1 - Threading Assist Guide			

Nerve Block Support Trays

Tray Components	Product Code	Reorder No.
HYPODERMIC NEEDLES		
27 Ga. x 1 1/4 in.	NB100	332100
25 Ga. x 5/8 in.	NB300	332105
25 Ga. x 1 1/2 in.	NB400	332103
18 Ga. x 1 1/2 in.		
3 mL Plastic Luer Lock Syringe with Pre-Attached 18 Ga. x 1 1/2 in. Needle		
SYRINGES		
1 mL Plastic - Luer Slip		
3 mL Plastic - Luer Lock		
5 mL Plastic - Luer Lock		
10 mL Plastic - Luer Lock		
20 mL Plastic - Luer Lock (2 per tray)		
20 mL Plastic - Luer Lock, Control Stroke		
PROCEDURAL DRUGS		
Lidocaine HCl (1%), 5 mL (skin wheal)		
DRAPES		
Clear Drape with Circular Fenestration		
Clear Drape with Rectangular Fenestration		
PREP ITEMS/OTHER		
Prep Sponges (3 per tray)		
ChlorPrep with Orange Tint - 3 mL Applicator		
Benzoin Swabstick		
Skin Marker		
Paper Ruler		
Filter Straw® Particulate Matter Filter		
CIV-Flex Transducer Cover and Ultrasound Gel		
0.2 µm Procedural Filter		
PinPad (Securement Device for 0.2 µm Procedural Filter)		
Steri-Strip Closure (card of 3)		
Tegaderm® 4 in. x 4 3/4 in. Dressing		
Needle Block Foam with Holder		
4 in. x 4 in. Gauze Sponges (4 per tray)		
Paper Towel, 3 Ply		
Paper Towel, 3 Ply (2 per tray)		
Drug Identification Label Set		

* All catheters packaged with thread assist guide and connector All trays: 10 Units/Case

NeedleVise is a registered trademark of Atrion Medical Products, Inc.

ChlorPrep is a registered trademark of CareFusion Corporation

Tegaderm and Steri-Strip are registered trademarks of 3M

CIV-Flex is a trademark of CIVCO Medical Instruments Co., Inc.

PROCEDURAL NERVE BLOCK TRAYS

Pain Control

CONTIPLEX® Continuous Nerve Block Trays PLEXUFIX® Single Shot Nerve Block Tray

NEW **NEW** **NEW** **NEW**

Tray Components

	Product Code	Reorder No.	CNB350TKUFO	CNB350TKUFC	CNB200TK	CNB400TK	CNB200TKU	CNB400TKU	CNB200TKUKU	CNB400TKUKU	SCNB2TK	SCNB4TK	NB200
PROCEDURAL NEEDLES - PERIPHERAL NERVE BLOCK													
17 Ga. x 3½ in. (90 mm), Non-Stimulating Tuohy Needle			•	•									
CONTIPLEX Tuohy 18 Ga. x 2 in. (50 mm)					•		•					•	
CONTIPLEX Tuohy 18 Ga. x 4 in. (100 mm)						•		•					•
CONTIPLEX Tuohy Ultra 18 Ga. x 2 in. (50 mm)									•				
CONTIPLEX Tuohy Ultra 18 Ga. x 4 in. (100 mm)										•			
PLEXUFIX 22 Ga. x 1½ in. (40mm), Non-Stimulating, 45° Bevel Plexus Needle													•
HYPODERMIC NEEDLES													
27 Ga. x 1¼ in.			•	•	•	•	•	•	•	•	•	•	•
25 Ga. x 1½ in.			•	•	•	•	•	•	•	•	•	•	•
3 mL Plastic Luer Lock Syringe with Pre-Attached 18 Ga. x 1½ in. Needle			•	•	•	•	•	•	•	•	•	•	•
SYRINGES													
1 mL Plastic - Luer Slip													•
5 mL Plastic - Luer Lock			•	•	•	•	•	•	•	•	•	•	•
10 mL Plastic - Luer Lock													•
20 mL Plastic - Luer Lock			•	•	•	•	•	•	•	•	•	•	•
20 mL Plastic - Luer Lock, Control Stroke													•
PNB CATHETERS *													
CONTIPLEX FX Springwound Catheter - 19 Ga., Open Tip (MR Unsafe)			•										
CONTIPLEX FX Springwound Catheter - 19 Ga., Closed Tip (MR Unsafe)				•									
CONTIPLEX Polyamide Catheter - 20 Ga., Closed Tip					•	•	•	•	•	•			
CONTIPLEX STIM Stimulating Catheter - 20 Ga., Closed Tip with Integrated Wire (MR Unsafe)											•	•	
PROCEDURAL DRUGS													
Epinephrine (0.1%), 1 mL													•
Lidocaine HCl (1%), 5 mL (skin wheal)			•	•	•	•	•	•	•	•	•	•	•
Lidocaine HCl (1.5%) with Epi, 5 mL (test dose)					•	•	•	•	•	•	•	•	•
Lidocaine (1.5%), 20 mL													•
Sodium Chloride (0.9%), 10 mL													•
DRAPES													
Clear Drape with Circular Fenestration				•	•						•	•	•
Clear Drape with Rectangular Fenestration			•	•			•	•	•	•			•
PREP ITEMS/OTHER													
ChlorPrep with Orange Tint - 3 mL Applicator			•	•	•	•	•	•	•	•	•	•	•
Benzoin Swabstick			•	•	•	•	•	•	•	•	•	•	•
Skin Marker													•
Paper Ruler					•	•	•	•			•	•	•
Plastic Needle Marker Disk													•
Filter Straw® Particulate Matter Filter			•	•	•	•	•	•	•	•	•	•	•
CIV-Flex Transducer Cover and Ultrasound Gel			•	•			•	•	•	•			•
Sideport Valve Assembly with Extension Tubing			•	•	•	•	•	•	•	•	•	•	•
0.2 µm Procedural Filter			•	•	•	•	•	•	•	•	•	•	•
PinPad (Securement Device for 0.2 µm Procedural Filter)			•	•	•	•	•	•	•	•	•	•	•
Steri-Strip Closure (card of 3)					•	•	•	•			•	•	
Steri-Strip Closure (card of 3; 2 cards per tray)			•	•					•	•			
Tegaderm® 4 in. x 4¾ in. Dressing					•	•	•	•			•	•	
Tegaderm® 4 in. x 4¾ in. Dressing (2 per tray)			•	•					•	•			
NeedleVISE®					•	•	•	•					
Needle Block Foam with Holder			•	•					•	•	•	•	•
4 in. x 4 in. Gauze Sponges (4 per tray)			•	•	•	•	•	•	•	•	•	•	•
Paper Towel, 3 Ply			•	•	•	•	•	•	•	•	•	•	•
Paper Towel, 3 Ply (2 per tray)													•
Drug Identification Label Set			•	•	•	•	•	•	•	•	•	•	•

* All catheters packaged with thread assist guide and connector

All trays: 10 Units/Case

NeedleVise is a registered trademark of Atrion Medical Products, Inc.
ChlorPrep is a registered trademark of CareFusion Corporation
Tegaderm and Steri-Strip are registered trademarks of 3M
CIV-Flex is a trademark of CIVCO Medical Instruments Co., Inc.

Description	Product Code	REF Number	Units Per cs
-------------	--------------	------------	--------------

HEMODIALYSIS PRODUCTS

Dialog⁺® Evolution Hemodialysis System



Dialog ⁺ Evolution Hemodialysis System	710200K	710200K	1
---	---------	---------	---

Standard Features Include:

- Color Touch Flat Screen monitor combined with off-screen hard key entry
- User-definable Profiling for UF, Na, Bicarbonate, Dialysate flow, Temperature, and Heparin
- Online Computerized Diagnostics
- Event Timer
- Online HELP functions
- Stand-by mode
- Technical Service Mode
- Multifunctional Supply Bin

Dialog⁺ Adimea™ – Precise, innovative Real-Time monitoring of the dialysis dose	7102233	7102233	1
Dialog ⁺ UltraPure Fluid Hemodialysis System Filter Kit	7102102	7102102	1
Dialog ⁺ Evolution Hemodialysis System with BIC Holder for Bicarbonate Cartridge	710200L	710200L	1

Dialog⁺ Hemodialysis System Optional Accessories

Patient Therapy Card Reader for the storage and reading of patient information	7105230	7105230	1
Patient Therapy Cards to be used with the Card Reader	7105232	7105232	5
Automatic Blood Pressure Monitor	3451487D	3451487D	1
Diacap® Ultra Pyrogen Filters	7107367	7107367	6
BIC Holder - Bicarbonate Cartridge Holder	7105171	7105171	1
Solcart B® Bicarbonate Cartridges			
Solcart B 650 grams	802	802	10
Solcart B 760 grams	803	803	10
Solcart B 1100 grams	805	805	8

Central Concentrate System – Acid
 Central Concentrate System – Bicarbonate

Call RTD Customer Service: 800-848-2066
 Call RTD Customer Service: 800-848-2066

Description	Product Code	REF Number	Units Per cs
Dialog⁺® Hemodialysis System Computer Interface Accessories			
Data Collection System Software Software Features Include: <ul style="list-style-type: none"> • Online downloading of machine data • Easily interfaces with other information systems 	PC0002	PC0002	1
Dialog ⁺ Reporter Software <ul style="list-style-type: none"> • Patient Record System for both machine and patient data • Database is accessed via Microsoft Access® 	DR0001	DR0001	1
Dialog ⁺ Hemodialysis System Computer Interface (DCI) Hardware Kit Hardware for each Dialog machine to allow the download of data to a software system.	7107218	7107218	1
HEMODIALYSIS ACCESSORIES			
Concentrate Container Caps*			
Blue Bicarb Cap	34517774	34517774	1
Red Acid Cap	34517766	34517766	1
Yellow Disinfection Cap	34514562	34514562	1
* Solid caps available for mixing purposes			
Concentrate Container Labels			
Bicarbonate – blue label	S20064	S20064	1
Acid – red label	S20065	S20065	1
Disinfection label	S20066	S20066	1
Concentrate Solution Container - 2½ gallons	604010	604010	1
Universal Artificial Kidney Holder with drip chamber support	S8020004	S8020004	1
Priming Disposal Bucket and Holder	S20046BH	S20046BH	1
Disinfection			
Liquid Citric Acid, 50%; 6L jug	8000	8000	1
Liquid Citric Acid, 50%; 10L jug	8001	8001	1

Microsoft Access is a registered trademark of Microsoft Corporation

RENAL THERAPIES / DIALYSIS PRODUCTS

Description	Product Code	REF Number	Units Per cs
REVERSE OSMOSIS WATER TREATMENT SYSTEMS			
 <p>Millenium M-750 Portable RO System</p> <p>Cart Assembly</p> <p>Standard Features Include:</p> <ul style="list-style-type: none"> Cart assembly to integrate RO into the Dialog® and Dialog+ Hemodialysis Systems Aluminum Construction Large Swivel Wheels with locking brakes Two tank pretreatment stand <p>Pre-Filter Kit with Filter Housing</p> <p>Cart only for RO, tanks, and filter</p>	Z1232429	Z1232429	1
	P00024P	P00024P	1
	Z14924	Z14924	1
	Z14753-1	Z14753-1	1

WATER TREATMENT SYSTEM ACCESSORIES AND MAINTENANCE SUPPLIES

External Carbon Exchange Tank – 0.25 cubic feet	Z122231	Z122231	1
---	---------	---------	---









PERACIDIN® Dialyzer Reprocessing Concentrate for the In vitro Cleaning and Sterilizing of Hollow Fiber Dialyzers

Two Liter Bottle	1632-22	1632-22	2
Gallon Size (3 Liter fill)	1632-04	1632-04	4
Peracidin Gallon Kit with Test Strips	1632-05	1632-05	4

Test Strips

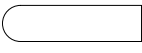
PeraSidual® Strips	1702-01	1702-01	100/btl
PeraChek® Test Strips	1701-01	1701-01	100/btl

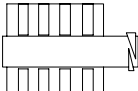
PeraChek, PERACIDIN and PeraSidual are registered trademarks of Alcavis HDC LLC

Description	Product Code	REF Number	Units Per cs
Dialyzer Re-Use Products			
 	Dialysate Port Caps	S0003	100
	Dialysate Port Caps, bulk	S0004	1000
 	Vented Dialysate Port Cap	S0005	100
 	Blood Port Caps, slip	S1001	100
	Blood Port Caps, slip, bulk	S1002	1000
 	Blood Port Caps, twist	S1003	100
	Blood Port Caps, twist, bulk	S1004	1000

AV Fistula Needles with MasterGuard® Anti-Stick Needle Protector, Fixed Wing – Twin Pack

Manufactured by MediSystems, a NxtStage Company

- Fistula needle has FingerShield® to protect against needlestick injuries
- Standard Bevel
- Backeye, Clamp
- 12 inch tubing; 16 inch tubing available in Single Pack

Twin Packs – Carton quantity: 250 needles – includes 120 pairs of AV fistula needles plus 10 single needles

14 Ga. x 1 inch	D9-2004MG	D9-2004MG	250
15 Ga. x 1 inch	D9-2005MG	D9-2005MG	250
15 Ga. x 1 inch LONG BEVEL FW	D9-2005MGLB	D9-2005MGLB	250
15 Ga. x 1¼ inch	D9-2015MG	D9-2015MG	250
16 Ga. x 1 inch	D9-2006MG	D9-2006MG	250
16 Ga. x 1 inch LONG BEVEL FW	D9-2006MGLB	D9-2006MGLB	250
16 Ga. x 1¼ inch	D9-2016MG	D9-2016MG	250
17 Ga. x 1 inch	D9-2007MG	D9-2007MG	250
17 Ga. x 1 inch LONG BEVEL FW	D9-2007MBLB	D9-2007MBLB	250

AV Fistula Needles with MasterGuard Anti-Stick Needle Protector, Fixed Wing – Single Pack

14 Ga. x 1 inch	S9-7004MG	S9-7004MG	250
15 Ga. x ¾ inch	S9-7435MG	S9-7435MG	250
15 Ga. x 1 inch	S9-7005MG	S9-7005MG	250
15 Ga. x 1 inch - LONG BEVEL	S9-7005MGLB	S9-7005MGLB	250
15 Ga. x 1 inch with 16 inch tubing	S9-7605MG	S9-7605MG	200
15 Ga. x 1¼ inch	S9-7015MG	S9-7015MG	250
15 Ga. x 1¼ inch with 16 inch tubing	S9-7615MG	S9-7615MG	200
16 Ga. x ¾ inch	S9-7436MG	S9-7436MG	250
16 Ga. x 1 inch	S9-7006MG	S9-7006MG	250
16 Ga. x 1 inch - LONG BEVEL	S9-7006MGLB	S9-7006MGLB	250
16 Ga. x 1 inch with 16 inch tubing	S9-7606MG	S9-7606MG	200
16 Ga. x 1¼ inch	S9-7016MG	S9-7016MG	250
16 Ga. x 1¼ inch with 16 inch tubing	S9-7616MG	S9-7616MG	200
17 Ga. x ¾ inch	S9-7437MG	S9-7437MG	250
17 Ga. x 1 inch	S9-7007MG	S9-7007MG	250
17 Ga. x 1¼ inch	S9-7017MG	S9-7017MG	250

RENAL THERAPIES / DIALYSIS PRODUCTS

Description	Product Code	REF Number	Units Per cs
AV Fistula Needles with MasterGuard® Anti-Stick Needle Protector, Rotatable Hub – Single Pack			
15 Ga. x 1 inch RH	S9-4005MG	S9-4005MG	250
15 Ga. x 1¼ inch RH	S9-4015MG	S9-4015MG	250
16 Ga. x 1 inch RH	S9-4006MG	S9-4006MG	250
16 Ga. x 1¼ inch RH	S9-4016MG	S9-4016MG	250
17 Ga. x 1 inch RH	S9-4007MG	S9-4007MG	250

ButtonHole® AVF Needle Sets

14 Ga. x 1 inch	BH-7004	BH-7004	250
14 Ga. x 1¼ inch	BH-7014	BH-7014	250
15 Ga. x ¾ inch	BH-7035	BH-7035	250
15 Ga. x 1 inch	BH-7005	BH-7005	250
15 Ga. x 1 inch Y-Single Needle Set	BH-3005	BH-3005	300
15 Ga. x 1¼ inch	BH-7015	BH-7015	250
16 Ga. x ¾ inch	BH-7036	BH-7036	250
16 Ga. x 1 inch	BH-7006	BH-7006	250
16 Ga. x 1 inch Y-Single Needle Set	BH-3006	BH-3006	250
16 Ga. x 1¼ inch	BH-7016	BH-7016	250
17 Ga. x ¾ inch	BH-7037	BH-7037	250
17 Ga. x 1 inch	BH-7007	BH-7007	250

ButtonHole Needle Sets with Steripick® for the effective and simple removal of the ButtonHole scab

Buttonhole with SteriPick in Twin Packs – case quantity 250 needles packaged as 115 pairs of two needles each plus 20 single needles

14 Ga. x 1 inch	BH-2004PE	BH-2004PE	250
15 Ga. x 1 inch	BH-2005PE	BH-2005PE	250
16 Ga. x 1 inch	BH-2006PE	BH-2006PE	250
17 Ga. x 1 inch	BH-2007PE	BH-2007PE	250
15 Ga. x ¾ inch	BH-2035PE	BH-2035PE	250
16 Ga. x ¾ inch	BH-2036PE	BH-2036PE	250
17 Ga. x ¾ inch	BH-2037PE	BH-2037PE	250

Buttonhole with Steripick in Single Packs

14 Ga. x 1 inch	BH-7004PE	BH-7004PE	250
15 Ga. x 1 inch	BH-7005PE	BH-7005PE	250
15 Ga. x 1 inch with 16 inch tubing	BH-7605PE	BH-7605PE	250
16 Ga. x 1 inch	BH-7006PE	BH-7006PE	250
16 Ga. x 1 inch with 16 inch tubing	BH-7606PE	BH-7606PE	250

Buttonhole with Steripick with Rotatable Hub

15 Ga. x 1 inch	BH-4005PE	BH-4005PE	250
-----------------	-----------	-----------	-----

ButtonHole, MasterGuard, and FingerShield and Steripick are registered trademarks of Medisystems Corporation, a company of Nxstage Medical Inc.

Description	Product Code	REF Number	Units Per cs
Streamline® Bloodlines Streamline Bloodline sets for the Dialog+ Hemodialysis System			
<ul style="list-style-type: none"> • Low volume design • Airless arterial and venous pressure pods • Locksite® needleless access port 			
Streamline Bloodline set for the Dialog+ Hemodialysis System	SL-2010M2096	SL-2010M2096	32
Streamline Bloodline set for the Dialog+ Hemodialysis System with SecureClip®	SL-2011M2098	SL-2011M2098	32
Streamline Bloodline set for the FMC 2008 Series	SL-2000M2095	SL-2000M2095	36
Streamline Bloodline Long Version for the FMC 2008 Series	SL-2000M2095L	SL-2000M2095L	32

**Renal Therapies /
Dialysis Products**

DIALYZERS
Diacap® α Polysulfone Dialyzers
Low and High Flux Dialyzers – α Polysulfone membrane, Gamma sterilized

LO PS 15	1.5m ²	7204002	7204002	20
HI PS 10	1.0m ²	7204100	7204100	20
HI PS 15	1.5m ²	7204102	7204102	20
HI PS 18	1.8m ²	7204103	7204103	20
HI PS 20	2.0m ²	7204104	7204104	20



Diacap α Polysulfone+ HiFlo 23 Dialyzer

Modified α Polysulfone technology for efficient high-flux dialysis and hemodiafiltration

HiFlo 23	2.33m ²	72036811	72036811	20
----------	--------------------	----------	----------	----

Locksite, SecureClip and Streamline are registered trademarks of NxStage Medical, Inc.

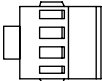
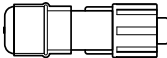
RENAL THERAPIES / DIALYSIS PRODUCTS

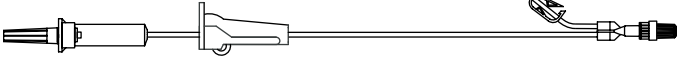
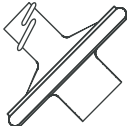
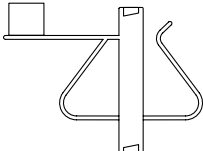
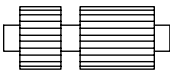
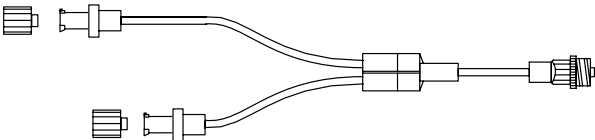
Description	Product Code	REF Number	Units Per cs
ANCILLARY DISPOSABLE PRODUCTS			
	B1000	418017	100
Blue Catheter Cap – non-injectable, male luer lock			
	7210485	7210485	100
Injection Cap – latex free without cap			
	IN2000	418020	100
Injection Cap – latex free, length 1-1/8 in.			
	IN4000	418030	100
Injection Cap – latex free, length 3/4 in.			
	IN1000	654237	1000
Injection Stopper			
	7210385	7210385	100
Administration Set with roller clamp, injection port, and luer lock tip			
	7210496	7210496	100
Transducer Protectors, bulk sterile, with protective cap			
	7210323	7210323	100
Bloodline Recirculation Connector			
	DMA1000	456080	100
Fistula Needle Recirculation Connector			
	D30000	351410	10
Wide Bore Y Extension Set for single needle			

Renal Therapies / Dialysis Products

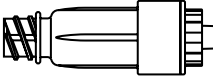
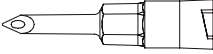
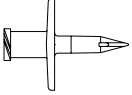
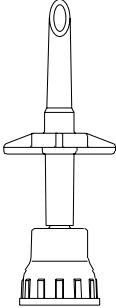
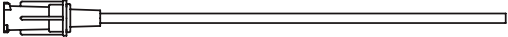
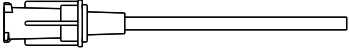
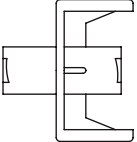
Description	Product Code	REF Number	Units Per cs
Needleless PRODUCTS			
	CSU100	415110	100
ULTRASITE® Capless Positive Pressure Valve			
	MP1000	415019	100
MICRO PIN®, non-vented for single dose vials			
	DP4000	413503	100
Dispensing Pin, non-vented, for multi dose vials			
	DP3500L	413501	50
Dispensing Pin with SAFSITE® valve for inverted bags			
	FS5000	415020	100
FILTER STRAW® 4 in. flexible straw for aspiration from glass ampules			
	FS5005	415021	100
FILTER STRAW 1¾ in. flexible straw for aspiration from glass ampules			
	FDC1000	415080	100
Fluid Dispensing Connector for filling unit dose syringes			

Renal Therapies /
Dialysis Products

Description	Product Code	REF Number	Units Per cs
			
Syringes and Needles for Use in Dialysis			
INJEKT™ 1mL Low Waste Syringe	9166017V	9166017V	1800
OMNIFIX® 3 mL LL	4610303-02	4610303-02	2400
OMNIFIX 3 mL LS	4610302-02	4610302-02	2400
OMNIFIX 5 mL LL	4617053V-02	4617053V-02	2000
OMNIFIX 5 mL LS	4610518-02	4610518-02	2000
OMNIFIX 10 mL LL	4617100V-02	4617100V-02	1200
OMNIFIX 10 mL LS	4611030-02	4611030-02	1200
OMNIFIX 20 mL LL	4617207V-02	4617207V-02	800
OMNIFIX 30 mL LL	4617304F-02	4617304F-02	600
OMNIFIX 3 mL LL Plus 20G x 1 in.	4610306-02	4610306-02	1600
OMNIFIX 3 mL LL Plus 21G x 1 in.	4610308-02	4610308-02	1600
OMNIFIX 3 mL LL Plus 21G x 1½ in.	4610309-02	4610309-02	1600
OMNIFIX 3 mL LL Plus 22G x 1½ in.	4610311-02	4610311-02	1600
OMNIFIX 3 mL LL Plus 23G x 1 in.	4610312-02	4610312-02	1600
OMNIFIX 3 mL LL Plus 27G x ½ in.	4610316-02	4610316-02	1600
OMNIFIX 5 mL LL Plus 22G x 1 in.	4610524-02	4610524-02	900
OMNIFIX 10 mL LL Plus 18G x 1 in.	4611031-02	4611031-02	900
OMNIFIX 10 mL LL Plus 18G x 1½ in.	4611033-02	4611033-02	900
OMNIFIX 10 mL LL Plus 20G x 1½ in.	4611034-02	4611034-02	900
OMNIFIX 10 mL LL Plus 21G x 1 in.	4611035-02	4611035-02	900
OMNIFIX 10 mL LL Plus 22G x 1 in.	4611037-02	4611037-02	900
OMNICAN®100 1 mL Insulin 30G x ½ in. PN	9151141SUS	9151141SUS	2400
OMNIFIX 1 mL TB 25G x 5/8 in. DET	9161422-02	9161422-02	1600

Renal Therapies / Dialysis Products

Call **800-848-2066** for additional sizes of syringes and needles offered by B. Braun Medical

Description	Product Code	REF Number	Units Per cs
-------------	--------------	------------	--------------

CONTINUOUS RENAL REPLACEMENT THERAPY (CRRT) PRODUCTS

Diapact® CRRT System

Renal Therapies /
Dialysis Products



Diapact CRRT System	7106510	7106510	1
Standard Features Include:			
<ul style="list-style-type: none"> • Continuous Therapies: CVVH, CVVHD/HFD, SCUF • High flow rates with intermittent dialysis capabilities • Ability to use any hemofilter or hemodialyzer • Single load cell • In line fluid warmer • Standard dialysis-type bloodline system with manifold 			
Diapact CRRT System Optional Features			
Plasma Therapies: PEX, PAP	P00023	P00023	1

Diapact CRRT System Tubing Sets

CVVHD/CVVHFD Tubing Set, unassembled kit	7210517	7210517	4
CVVHD/CVVHFD Tubing Set, manifold kit	7210513	7210513	4
Plasma Exchange (PEX) Tubing Set	7210518	7210518	4
CRRT Connection Line	7210528	7210528	50
Bloodline Extension Set (3 ft tubing)	PP001922	PP001922	10
Filter Priming Set - includes two(2) twist lock blood port caps	PP001923	PP001923	24

Description	Product Code	REF Number	Units Per cs
-------------	--------------	------------	--------------

SOLUTIONS FOR CRRT

Duosol™ Bicarbonate Dialysate Solution



- Sterile, ready-to-use, nonpyrogenic bicarbonate dialysate solution
- Supplied in single use 2-chamber bags equal to 5000 mL
- **Color Coded Bags**
- **Barcoded**
- Various formulations available

Product Code	4551	4552	4553	4554	4555	4556
	Bicarbonate 35 Dialysate K0/Ca3 (mEq/L)	Bicarbonate 35 Dialysate K2/Ca3 (mEq/L)	Bicarbonate 25 Dialysate K2/Ca0 (mEq/L)	Bicarbonate 32 Dialysate K2/Ca0 (mEq/L)	Bicarbonate 35 Dialysate K4/Ca3 (mEq/L)	Bicarbonate 25 Dialysate K4/Ca0 (mEq/L)
Na	140	140	136	136	140	136
K	0	2	2	2	4	4
Ca	3	3	0	0	3	0
Mg	1	1	1.5	1.5	1	1.5
Cl	109	111	115	107.5	113	117
Lactate	0	0	0	0	0	0
HCO ₃	35	35	25	32	35	25
Glucose g/L	1	1	0	0	1	0
mOsmol/L	292	296	278	278	300	282

Duosol Bicarbonate 35 (without Potassium)	4551	4551	2
Duosol Bicarbonate 35 with 2mEq/L Potassium	4552	4552	2
Duosol Bicarbonate 25 without Calcium	4553	4553	2
Duosol Bicarbonate 32 without Calcium	4554	4554	2
Duosol Bicarbonate 35 with 4mEq/L Potassium	4555	4555	2
Duosol Bicarbonate 25 with 4mEq/L Potassium (without Calcium)	4556	4556	2

Renal Therapies /
Dialysis Products

Duosol is a trademark of B. Braun Medical Inc.

Description	Product Code	REF Number	Units Per cs
-------------	--------------	------------	--------------

H.E.L.P.® LDL-APHERESIS THERAPY



H.E.L.P. (Heparin-induced Extracorporeal LDL Precipitation Therapy) can effectively lower the LDL-C levels in hypercholesterolemic patients.

Plasmata® Futura Apheresis Treatment System

The Plasmata Futura is an automated system for LDL apheresis designed specifically for the performance of H.E.L.P. therapy treatments.

Call 800-848-2066

H.E.L.P. Plasmata Futura Treatment Kit and Solutions

To complete one H.E.L.P. LDL-Apheresis Therapy Treatment you will need: one Futura treatment kit with preconnected filters and lines, three bags of H.E.L.P. BicEl dialysate solution, one 30 mL vial of heparin, one bag of sodium acetate buffer, two bags of 3000 mL 0.9% sodium chloride solution for priming and rinsing, and 2000 mL of 0.9% sodium chloride solution for restitution.

H.E.L.P. Futura Set (Treatment Unit)	7210925	7210925	4
Preconnected Filters and Lines:			
One (1) Plasmafilter Haemoselect L 0.5			
One (1) H.E.L.P. precipitate filter			
One (1) H.E.L.P. heparin adsorber			
One (1) Ultrafilter SMC 1.8			
Venous Line, Plasma-Buffer Line, Filtrate Line, Connection Line, Dialysate Drainage Line Venting Line			
Individually Packaged in Kit:			
Three (3) Drainage Bags for Dialysate			
Dialyzing Fluid Line			
Arterial Line			
Empty Bag for Priming			
Solutions			
H.E.L.P. BicEl Dialysate	4376	4376	2
<i>Three (3) bags needed per treatment</i>			
H.E.L.P. Heparin Sodium Solution, 30 mL	7061188	7061188	1
H.E.L.P. Sodium Acetate Buffer Solution		28	4
0.9% NaCl, 3000 mL for priming and rinsing	34	34	4
<i>Two (2) bags needed per treatment</i>			
0.9% NaCl - one 1500 mL and one 500 mL set, for restitution	4067	4067	4 sets

Introcan Safety® IV Catheters

Size	Catheter Length	Catheter Material	Straight or Wing	REF Number	Units Per cs
24G	0.55 inch	PUR (polyurethane)	S	4251611-02	200
24G	0.55 inch	PUR	W	4253511-02	200
22G	1 inch	PUR	S	4251628-02	200
22G	1 inch	PUR	W	4253540-02	200
20G	1 inch	PUR	S	4251652-02	200
20G	1 inch	PUR	W	4253574-02	200
20G	1¼ inch	PUR	S	4251644-02	200
20G	1¼ inch	PUR	W	4253566-02	200
18G	1¼ inch	PUR	S	4251687-02	200
18G	1¼ inch	PUR	W	4253604-02	200
18G	1¾ inch	PUR	S	4251679-02	200
18G	1¾ inch	PUR	W	4253590-02	200
16G	1¼ inch	PUR	S	4251709-02	200
16G	2 inches	PUR	S	4251695-02	200
16G	2 inches	PUR	W	4253612-02	200
14G	2 inches	PUR	S	4251717-02	200
14G	2 inches	PUR	W	4253639-02	200
24G	0.55 inch	FEP	S	4252511-02	200
24G	0.55 inch	FEP	W	4254512-02	200
22G	1 inch	FEP	S	4252519-02	200
22G	1 inch	FEP	W	4254511-02	200
22G	1¾ inch	FEP	S	4252520-02	200
20G	1 inch	FEP	S	4252543-02	200
20G	1 inch	FEP	W	4254546-02	200
20G	1¼ inch	FEP	S	4252535-02	200
20G	1¼ inch	FEP	W	4254538-02	200
20G	1¾ inch	FEP	S	4252527-02	200



18G	1¼ inch	FEP	S	4252560-02	200
18G	1¼ inch	FEP	W	4254562-02	200
18G	1¾ inch	FEP	S	4252551-02	200
18G	2½ inch	FEP	S	4252561-02	200
16G	1¼ inch	FEP	S	4252586-02	200
16G	2 inches	FEP	S	4252578-02	200
16G	2 inches	FEP	W	4254570-02	200
14G	1¼ inch	FEP	S	4251890-02	200
14G	2 inches	FEP	S	4252594-02	200
14G	2 inches	FEP	W	4254597-02	200

Introcan Safety Thin Wall IV Catheters

24G	0.55 inch	PUR	W	4251614-02	200
24G	0.55 inch	PUR	S	4251607-02	200
24G	¾ inch	PUR	S	4251601-02	200
24G	¾ inch	PUR	W	4253523-02	200
24G	0.55 inch	FEP	W	4251609-02	200
24G	0.55 inch	FEP	S	4251612-02	200
24G	¾ inch	FEP	S	4252500-02	200
24G	¾ inch	FEP	W	4254503-02	200

Introcan Safety® 3 Closed IV Catheters

Size	Catheter Length	Catheter Material	Straight or Wing	REF Number	Units Per cs
24G	0.75 inch	PUR (polyurethane)	W	4251127-02	200
22G	1 inch	PUR	W	4251128-02	200
20G	1 inch	PUR	W	4251129-02	200
20G	1.25 inch	PUR	W	4251130-02	200
18G	1.25 inch	PUR	W	4251131-02	200
18G	1.75 inch	PUR	W	4251132-02	200

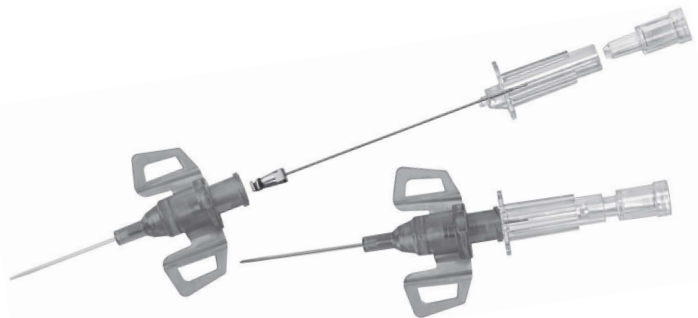

WHIN® SAFE HUBER INFUSION NEEDLE SETS

WHIN SAFE Huber Needle Set

Female luer connector, on/off clamp, 90° WHIN Safe Huber needle. Pressure rated to 300 psi. Components do not contain DEHP or natural rubber latex; lipid compatible. Priming volume: 0.23 mL Length: 7 in. (18 cm)



Description	REF Number	Units Per cs
22 Ga. x 0.75 in.	571112	100
22 Ga. x 1.0 in.	571114	100
22 Ga. x 1.5 in.	571116	100
20 Ga. x 0.75 in.	573112	100
20 Ga. x 1.0 in.	573114	100
20 Ga. x 1.5 in.	573116	100
19 Ga. x 0.75 in.	575112	100
19 Ga. x 1.0 in.	575114	100
19 Ga. x 1.5 in.	575116	100

WHIN SAFE Huber Needle Set with Open Y-injection Site

Female luer connector, two on/off clamps, open Y-injection site, 90° WHIN Safe Huber needle. Pressure rated to 300 psi. Components do not contain DEHP or natural rubber latex; lipid compatible. Priming volume: 0.3 mL Length: 8 in. (20 cm)(18 cm)

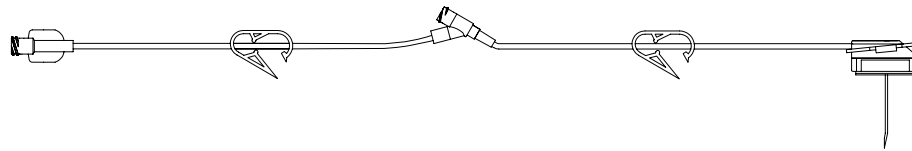

22 Ga. x 0.75 in.	577112	100
22 Ga. x 1.0 in.	577114	100
22 Ga. x 1.5 in.	577116	100
20 Ga. x 0.75 in.	579112	100
20 Ga. x 1.0 in.	579114	100
20 Ga. x 1.5 in.	579116	100
19 Ga. x 0.75 in.	581112	100
19 Ga. x 1.0 in.	581114	100
19 Ga. x 1.5 in.	581116	100

WHIN SAFE Huber Needle Set with Needle-free Injection Site

Female luer connector, two on/off clamps, needle-free injection site, 90° WHIN Safe Huber needle. Components do not contain DEHP or natural rubber latex; lipid compatible. Priming volume: 0.7 mL Length: 8 in. (20 cm)(18 cm)

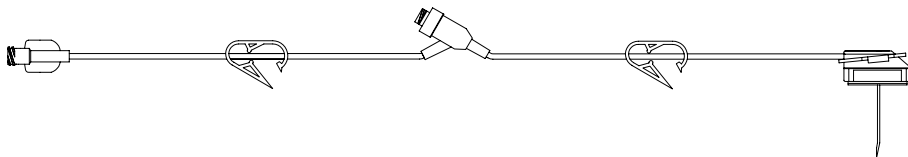

22 Ga. x 0.5 in.	583110	100
22 Ga. x 0.75 in.	583112	100
22 Ga. x 1.0 in.	583114	100
22 Ga. x 1.5 in.	583116	100
20 Ga. x 0.5 in.	585110	100
20 Ga. x 0.75 in.	585112	100
20 Ga. x 1.0 in.	585114	100
20 Ga. x 1.5 in.	585116	100
19 Ga. x 0.75 in.	587112	100
19 Ga. x 1.0 in.	587114	100
19 Ga. x 1.5 in.	587116	100

VASCULAR ACCESS PRODUCTS

Description	Product Code	REF Number	Units Per cs
-------------	--------------	------------	--------------

WHIN® WINGED HUBER INFUSION NEEDLES

Huber Needle

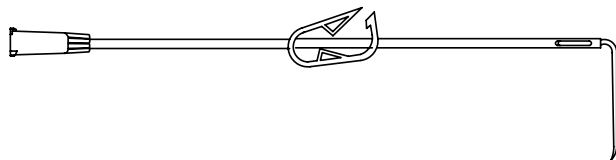

Female luer connector, on/off clamp, 90° huber needle. Components do not contain DEHP or natural rubber latex. Priming volume: 0.25 mL Length: 7 in. (17.8 cm)

19 Ga. x 3/4 in.	HW1976HRF	471729	20
19 Ga. x 1 in.	HW1916HRF	471730	20
20 Ga. x 3/4 in.	HW2076HRF	471731	20
20 Ga. x 1 in.	HW2016HRF	471732	20
20 Ga. x 1 1/2 in.	HW2026HRF	471693	20
22 Ga. x 1/2 in.	HW2256HRF	471687	20
22 Ga. x 3/4 in.	HW2276HRF	471733	20
22 Ga. x 1 in.	HW2216HRF	471734	20
22 Ga. x 1 1/2 in.	HW2226HRF	471686	20

Huber Needle Set with Injection Site

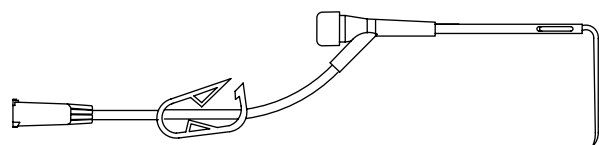

Female luer connector, on/off clamp, injection site, 90° huber needle. Components do not contain DEHP or natural rubber latex;
Priming volume: 0.38 mL Length: 7 in. (17.8 cm)

20 Ga. x 3/4 in.	HW2076YHRF	471691	20
20 Ga. x 1 in.	HW2016YHRF	471720	20
22 Ga. x 3/4 in.	HW2276YHRF	471709	20
22 Ga. x 1 in.	HW2216YHRF	471714	20

Description	Product Code	REF Number	Units Per cs
DRESSING CHANGE KITS, LATEX-FREE			
Flex Packaging			
Dressing Change Kit with Opsite® IV 3000 Dressing	DC921	375190	30
Dressing Change Kit with Opsite IV 3000 Dressing and ChloroPrep® 3.0 mL Applicator	DC157WCHG	375185	30
Dressing Change Kit with Tegaderm® Dressing and ChloroPrep 3.0 mL Applicator	DC157STCHG	375186	30

375190
375185
375186

KIT COMPONENTS			
CSR Wrap - 17 in x 19 in		1	1
Towel/Drape	1		
Face Mask	1	1	1
Gloves	1	1	1
ChloroPrep Solution - 3.0 mL Applicator		1	1
PVP Swabstick - 3's	1		
Alcohol Swabstick - 3's	1	1	1
PVP Ointment	1		
Non-woven IV Split Sponge - 2 in x 2 in	1	1	1
Gauze Sponge - 2 in x 2 in	1	1	1
Gauze Sponge - 4 in x 4 in	1	1	1
Non-adhering Dressing - 2 in x 2 in	1	1	1
Dressing Change Label	1	1	1
Opsite IV 3000 Dressing - 4 in x 5½ in	1	1	
Tegaderm Dressing - 4 in x 4¾ in			1
Roll of Tape	1	1	1

Vascular Access

Design exactly what you need with our Custom Kit Program

- Convenient and economical - B. Braun offers a complete list of components that can be designed to fit a customer's needs in one sterile package
- Choose from a variety of transparent dressings, skin preparation products, and safety devices

ChloroPrep is a registered trademark of Cardinal Health, Inc.
Tegaderm is a registered trademark of 3M
Opsite is a registered trademark of T.J. Smith and Nephew, Ltd.

VASCULAR ACCESS PRODUCTS

Description	Product Code	REF Number	Units Per cs
IV START KITS, LATEX-FREE			
Flex Packaging			
IV Start Kit with Opsite IV 3000® Dressing	IV200	375189	50
IV Start Kit with Opsite IV 3000 Dressing and ChloroPrep® SEPP® 0.67mL Applicator	IV200C	375188	50
IV Start Kit with Tegaderm® Dressing, EMS Basic	IV950T	375195	50
IV Start Kit with Tegaderm Dressing and ChloroPrep SEPP 0.67mL Applicator	IV930TCHG	375176	50
IV Start Kit with Tegaderm Dressing, ChloroPrep SEPP 0.67mL Applicator, StatLock Securement Device	IV941TSISCHG	375177	50
IV Start Kit with Tegaderm Dressing, ChloroPrep SEPP 0.67mL Applicator, StatLock Securement Device, and ULTRASITE® Needle-free IV System Extension Set - 8 in. (20.3 cm)	IV940TSISCHG	375171	50
Same as 375171 plus powder-free gloves and drape	IV930TSISCHG	375175	50

375189 375188 375195 375176 375177 375171 375175

KIT COMPONENTS

Towel/Drape							1
Gloves (1 medium pair/wallet)	1	1					
Gloves (1 medium pair/wallet) - Powder-Free				1			1
Alcohol Prep Pad	1	1	1	1			
PVP Prep Pad	1						
Tourniquet	1	1	1	1	1	1	1
Gauze Non-Woven (2 in x 2 in)	2	2	2	2	2	2	2
IV Label	1	1		1	1	1	1
Roll of Tape	1	1	1	1			
Opsite IV 3000 Dressing - 2 ³ / ₈ in x 2 ³ / ₄ in	1	1					
Tegaderm Dressing - 2 ³ / ₈ in x 2 ³ / ₄ in			1	1	1	1	1
ChloroPrep Solution - 0.67 mL SEPP Applicator		1		1	1	1	1
StatLock® Securement Device					1	1	1
ULTRASITE Extension Set (REF #473448)						1	1

Design exactly what you need with our Custom Kit Program

- Convenient and economical - B. Braun offers a complete list of components that can be designed to fit a customer's needs in one sterile package
- Choose from a variety of transparent dressings, skin preparation products, and safety devices

ChloroPrep and SEPP are registered trademarks of Cardinal Health, Inc.
 Tegaderm is a registered trademark of 3M
 Opsite is a registered trademark of T.J. Smith and Nephew, Ltd.
 Statlock is a registered trademark of C. R. Bard, Inc.

Thank you for your interest in B. Braun Medical Inc. ("B. Braun") products. The following provisions set forth the terms and conditions on which B. Braun sells its products.

Terms of Sale: Purchase of any products sold by B. Braun shall be subject to and expressly limited by the terms and conditions contained herein. No changes to, waiver of, or addition to any of these terms and conditions shall be effective unless agreed to in writing and signed by B. Braun. Buyer acknowledges and agrees that these terms and conditions supersede the terms and conditions of any purchase order or other documentation used by Buyer and, except for delivery and billing addresses, and quantities prices and items ordered, any conflicting or additional terms are void and have no effect, but that Buyer may place orders by use of purchase orders and other documentation for its convenience purposes only. Notwithstanding the foregoing, B. Braun reserves the right at any time to amend these terms and conditions, and Buyer shall be deemed to accept such amended terms and conditions by ordering products herein offered after the date of such amendment. Additional special terms and conditions of B. Braun may be applicable with respect to certain products.

Minimum Order Quantity: All products must be ordered in full case quantities. Orders received with a value of less than \$250.00 will be subject to a handling charge of \$40.00. Wholesalers and Distributors are subject to a handling charge of \$75.00 for orders less than \$1,000.00.

Prices: All pricing quotes must be documented in writing and signed by B. Braun to be valid. Prices quoted, unless otherwise stated, refer to full case quantities. All prices are firm for 30 days from the date quoted. B. Braun reserves the right to change the prices and specifications of its products at any time without notice.

Products purchased from distributors will be at the prices set by those distributors and subject to the terms and conditions of sale of the distributor.

Tax Information: Any tax, assessment, duty, custom or other fee of any nature imposed upon the products, their sale, transportation, delivery, use or consumption shall be paid by Buyer in addition to the price quoted or invoiced. If B. Braun is required to prepay any such tax or fee, Buyer will reimburse B. Braun. Buyer must provide B. Braun with a resale/exemption certificate in order to avoid the withholding of applicable taxes. No refund or adjustment to previously withheld taxes will be made by B. Braun sixty (60) days after the invoice date. Proof of certification should be mailed to: B. Braun Medical Inc., 824 Twelfth Avenue, Bethlehem, PA 18018-0027.

Payment: Payment terms are net 30 days from date of invoice. Credit card payments will not be accepted without prior approval from B. Braun. Buyer's obligation to pay outstanding invoices and all other amounts is absolute and unconditional and is not subject to any abatement, reduction, set-off, defense, counterclaim, interruption, deferment or recoupment for any reason whatsoever. Balances remaining unpaid at due date are subject to an interest charge of 1.50% per month or the highest rate permitted by law, whichever is lower, until paid. Any discounts, rebates, administrative fees, credits, or other fees due or owed to Buyer will be applied against delinquent balances before payment or reimbursement is made.

Any disputed amounts should be reported immediately and remitted with the undisputed amount by the payment due date. If B. Braun agrees with the billing dispute, B. Braun will credit Buyer the amount of the agreed-upon billing dispute. All billing disputes must be made within six (6) months of the applicable invoice date, or will be deemed to be waived.

B. Braun reserves the right in its sole discretion to require prepayment from any Buyer at any time and may refuse to sell and/or withhold further shipment until all overdue balances are made current. Buyer shall be liable for, and shall reimburse B. Braun for all costs and expenses it may incur in connection with collection of any amounts owed to B. Braun or enforcement of its rights, including without limitation, reasonable attorneys' fees and expenses, court costs, and cost of collection agencies.

Returned Goods Policy: Product returns are subject to the following conditions:

1. All returns are subject to the prior authorization of B. Braun, in its discretion. Buyer must notify Customer Support at (800) 227-2862 and complete a Return Request Form. The Return Request Form requires lot numbers, quantities and catalog numbers along with a specific reason for return. Customer Support will either authorize or deny the request for return. Only items appearing on an approved Return document are acceptable for return. Product returns will only be accepted from the original purchaser. Product returns will not be accepted from third party return companies. Unauthorized returns will be destroyed and no credit issued. All authorized returned goods must be shipped freight prepaid to the B. Braun location indicated on the Return document, except B. Braun will pay freight costs for Product shipped-in-error.

General Ordering Information and Terms of Sale

2. All Products returned within 30 days of delivery are subject to a 25% restocking charge, except for Products shipped-in-error. Products returned after 30 days are considered excess stock and will be eligible for 50% credit. No Products will be accepted for return after 90 days from the date of delivery.
3. Subject to paragraph 2 above, credit will be issued at the net purchase price for all authorized returns provided:
 - a. Products have at least one year shelf-life remaining, or products with original expiration dating of eighteen months or less have at least six months shelf-life remaining.
 - b. Proper authorization has been obtained prior to return of products.
 - c. Products are in their original packaging.
 - d. Products are current inventory items.
 - e. The Products have been shipped and billed to Buyer by B. Braun, and Buyer has paid for said Products.
4. Certain Products are **not eligible for return**. These are:
 - a. Products that have deteriorated because of improper storage, handling, abuse or other factors.
 - b. Products that have been opened, partly used or which the labels or seals have been removed or tampered.
 - c. Products that have been involved in a special promotion sale.
 - d. Broken, damaged or opened cases. Resealed cartons are not eligible for return.
 - e. Special products made to Buyer's specification.
 - f. Sets over two (2) years old, flush syringe products, infusion systems devices, related accessories and IV poles.
5. Products that are to be returned for repair (e.g., medical device equipment) must be accompanied by an approved Repair Notification.

Expiration Date: On dated products, the expiration date is shown as a month and year, e.g., August 2012, 8/12. The date of expiration is the last day of the given month, e.g., August 31, 2012.

Credits for returned goods are conditioned upon B. Braun's inspection and approval of such goods upon their return. If B. Braun determines, in its discretion, that any returned goods are not eligible for return due to any of the reasons provided in paragraph 4 above, Buyer will not receive a credit, even if an Return document was issued. No advance credits will be accepted.

Warranty: With respect to disposable products, B. Braun warrants to the original purchaser that, at time of delivery, each standard product manufactured by B. Braun shall be free of defects in material and workmanship and, when used for the purposes and indications described on the labeling, is fit for the purposes and indications described on the labeling. All warranties for a product shall expire as of product expiration date, or if none, after one (1) year from the date of shipment from B. Braun. B. Braun's warranty hereunder shall not apply if: (i) a product is not used in accordance with its instructions or if it is used for a purpose not indicated on the labeling, (ii) any repairs, alterations or other work has been performed by Buyer or others on such item, other than work performed with B. Braun's authorization and according to its approved procedures; or (iii) the alleged defect is a result of abuse, misuse, improper maintenance, accident or the negligence of any party other than B. Braun. The warranty set forth herein is conditioned upon proper storage, installation, use and maintenance in accordance with applicable written recommendations of B. Braun. The warranty furnished hereunder does not extend to damage to items purchased hereunder resulting in whole or in part from the use of components, accessories, parts or supplies not furnished by B. Braun.

B. Braun's sole obligation shall be to repair or replace, at B. Braun's option, any defective component or item and pay transportation expenses for such replacement. Buyer shall provide labor for the removal of the defective component or item and installation of its replacement at no charge to B. Braun. Buyer shall bear all risk of loss or damage to returned goods while in transit. In the event no defect or breach of warranty is discovered by B. Braun upon receipt of any returned item, the item will be returned to Buyer at Buyer's expense and Buyer will reimburse B. Braun for the transportation charges, labor and associated charges incurred in testing the allegedly defective item.

Except as expressly provided herein, B. Braun makes no representation or warranty of any kind, expressed or implied with respect to any products, parts or services provided by B. Braun including, but not limited to, the implied warranties of merchantability and fitness for a particular purpose. Products distributed, but not manufactured, by B. Braun are not warranted by B. Braun and Buyer must instead rely on the representations and warranties, if any, provided directly to Buyer by the manufacturer of such product. The sole and exclusive remedy for breach of any warranty is limited to the remedies provided in the paragraph above.

Warranties for infusion system devices are provided in a separate warranty document.

Miscellaneous:

1. Any required notices shall be given in writing, in the case of B. Braun, at the address set forth below, and in the case of Buyer, at the address designated on Buyer's purchase order or to such other address as either party may substitute by written notice to the other and shall be deemed given upon personal delivery, overnight delivery or three days following deposit in the mail.
2. Except as expressly provided herein, no changes or modifications to, or waiver of, any of these terms and conditions shall be valid or binding on either party unless in writing and signed by an authorized representative of each party. B. Braun's failure or delay to exercise or enforce any of its rights hereunder shall not constitute or be deemed to be a waiver of such rights or forfeiture of such rights, and B. Braun may, at its option, from time to time, exercise any of its rights or remedies.
3. These Terms bind Buyer and its successors and permitted assigns.
4. B. Braun will use its reasonable efforts to fill orders, but B. Braun shall not be liable for nonperformance or delays caused by a shortage of raw materials, manufacturing problems, delivery or labor problems, priorities, acts of regulatory agencies or judicial bodies, discontinuation of a product line, acts of God or third parties, infringement claims, or other causes beyond its reasonable control. Buyer agrees that in such events B. Braun may allocate products among all purchasers as it deems reasonable, without liability. B. Braun reserves the right from time to time to substitute a product with a product that has the same function as such product, or to delete a product.
5. The products are sold subject to Pennsylvania law. These terms and any dispute or claim relating to these terms or the sale of products ("Claim") shall be governed by and construed under Pennsylvania law, notwithstanding its law of conflicts of law. If any Claim cannot be settled amicably between the parties, such Claim shall be tried by a court and not a jury. Buyer expressly and unconditionally waives its rights to a jury trial in any such Claim.
6. B. Braun shall promptly deliver written notice or verbal, followed by written, notice of any recall of Product. Should the recall require Products be removed from the market, B. Braun shall, to the extent reasonably possible and at B. Braun's option, replace any such recalled Products as soon as practicable with comparable Products not subject to such recall or repair any such recalled Products and return them to Buyer.
7. Buyer may not change, adulterate, obscure, remove or deface trademarks, tradenames or labels appearing on any Product of B. Braun.
8. If the pricing offered by B. Braun to a Buyer constitutes a discount or other reduction in price under Section 1128(b)(3)(a) of the Social Security Act 42 U.S.C. 1320a-7b(b)(3)(a), and C.F.R. § 1001.952(h), Buyer shall disclose the discount or reduction in price to the fullest extent required under any state or federal program that provides cost or charge-based reimbursement to Buyers for products. This act requires, among other things, that Buyer fully and accurately report on any claim or request for payment it submits to Medicare and Medicaid the actual purchase price paid by Buyer for products, net of any discounts, rebates or allowances provided hereunder. Buyer may also be required, upon request, to provide documentation of the discount or other reduction in price to the Secretary of Health and Human Services.
9. In all cases, all intellectual property rights in and to, and all technology relating to, the Products supplied to Buyer, their design and all improvements thereto or thereof, whether or not such Product, design or improvement is made pursuant to Buyer's specifications or at Buyer's expense, shall be and remain the exclusive property of B. Braun.
10. Any knowledge or information that Buyer may disclose to B. Braun shall not be deemed to be confidential or proprietary information, and shall be acquired by B. Braun free from any restriction.
11. B. Braun shall not in any event be liable to buyer for any indirect, incidental, special, punitive or consequential damages (including any damage for lost profits), or otherwise arising out of or in connection with furnishing of products, parts or service hereunder, or the performance, use of, or inability to use any products, parts or service, or otherwise, whether based in contract, warranty, tort, including without limitation, negligence, or any other legal or equitable theory. B. Braun's total liability for any claim or action shall not exceed the purchase price of the products out of which such claim or action arose.
12. If any of the products are medical devices, Buyer acknowledges that it is familiar with the Safe Medical Devices Act of 1990 (the "Devices Act") and the reporting obligations imposed on device users thereunder. In this regard,

Buyer agrees to notify B. Braun within ten (10) days of the occurrence of any event identified in the Devices Act imposing a reporting obligation on Buyer and/or B. Braun (except for events representing an imminent hazard that require notification to the United States Food and Drug Administration (the "FDA") within seventy-two hours, in which case, such notice will be delivered to the other party immediately). Buyer shall maintain adequate tracking for the products to enable B. Braun to meet the FDA requirements applicable to the tracking of medical devices.

13. Buyer shall purchase the products for its own use only, and shall not resell the products to any other party. Buyer represents it has examined the products and that they are acceptable and clinically suitable for its intended purposes.

Shipping:

1. Freight charges will be prepaid when orders are shipped via a transportation mode and carrier selected by B. Braun. Unless otherwise stated in an agreement, shipment of infusion systems devices will be made F.O.B. Origin.
2. When expedited delivery, specialized service, or alternate transportation modes are requested, or if requests are inconsistent with efficient distribution practices, an additional charge to cover the premium expense will be added to the invoice. Inside deliveries are subject to additional charges based on current common carrier rates or hourly rates. Palletized deliveries are encouraged.
3. Products will be shipped on a scheduled order and delivery basis. Orders shipped outside Buyer's order and delivery schedule may be subject to a handling charge of \$75.00. B. Braun will provide proof of delivery upon request.

Damage or Loss in Transit: Identity of items and extent of damage or loss must be noted on Buyer's copy of delivery document by the agent of the transportation company. If damage is discovered after receipt of shipment, notify the transportation company immediately and request that inspection be made and an inspection report rendered. Buyer must report concealed shortages or damages within palletized shipments to B. Braun Customer Support within 3 business days of delivery or credit will not be allowed. In addition, Buyer must provide B. Braun with a copy of Buyer's claim request accompanied by a delivery receipt or an inspection report upon which the transportation company has properly noted damage or loss, and B. Braun will issue a credit for the loss or damage and file a claim with the carrier. If such information is not received within ten (10) days of delivery, no credit will be issued.

Send copy of carrier freight bill to Customer Support indicating item and quantity damaged or not received.

Count and inspect your freight before carrier departs. Damaged merchandise should not be accepted.

Please forward all information to Attn: Customer Support, B. Braun Medical Inc., 901 Marcon Blvd., Allentown, PA 18109. (800) 227-2862.

For Order Placement: B. Braun welcomes orders either by telephone, fax, mail or electronically. For telephone orders, please call (800) 227-2862. Faxed orders should be sent to: (610) 266-6122. For infusion devices, call (800) 627-7867 or fax (610) 266-2429. In Canada, please call (800) 624-2920 or fax (800) 624-2939. Mail orders should be directed to Attn: Customer Support, B. Braun Medical Inc., 901 Marcon Blvd, Allentown, PA 18109.

Trademarks

Trademarks of B. Braun Medical Inc. and its affiliates:

ADD-PRO	Adimea	Chemo Dispensing Pin	DoseCom	DoseGuard
DoseScan	Duosol	EPICAN	Hyperformer	Injekt
ONGUARD	PIC	Pin Pad	QC Tester	RateGuard
RED CAP	SAFEPORT	Superset	Transofix	UniSpike
ULTRABLOCK	ULTRAPORT			

Registered trademarks of B. Braun Medical Inc. and their affiliates:

addEASE	ADDitIV	BIG TAB	B-Plex	CAPS
CARESITE	ClearChoice-DCB	Clip Lock	CONTIPLEX	Diacap
Diacap α Polysulfone	Dialines	Dialog+	Diapact	DISCOFIX
DoseTrac	DUPLEX	ESPOCAN	EXCEL	Filterflow
FILTER STRAW	FreAmine	FreAmine HBC	H.E.L.P.	HepatAmine
HESpan	Horizon NXT	Hyperlyte	Infusomat	Introcan Safety
Isolyte	MICRO PIN	MINI-SPIKE	MULTI-AD	NephrAmine
Omnican	OMNIFIX	Outlook	PAB	PENCAN
Perfusor	PERIFIX	Physiolyte	PINNACLE	Plasmat
PLEXUFIX	ProcalAmine	Prontosan	Rate Flow	SAFELINE
SAFSITE	Solcart B	SPIN-LOCK	SPINOCAN	STIMUPLEX
TrophAmine	ULTRASITE	VISTA	WHIN	

6000 CMS is a trademark and PainSmart is a registered trademark of Moog, Inc.

BodyGuard and BodyComm are registered trademarks of CME America, LLC

ChloraPrep, SEPP and T-Pak are registered trademarks of Cardinal Health

CIV-Flex is a trademark of CIVCO Medical Instruments Company, Inc.

DuraPrep, Steri-Strip and Tegaderm are registered trademarks of 3M

Medic is a registered trademark of Medisystems Corporation

Microsoft Access and Windows are registered trademarks of Microsoft Corporation

Monoject is a registered trademark of Tyco

NeedleVISE is a registered trademark of Atrion Medical Products, Inc.

OmniPal is a trademark and Patient Pal, Trans-Pal, Versa Pole, and Walk 'N' Roller are registered trademarks of Pryor Products, Inc.

OpSite is a registered trademark of T.J. Smith and Nephew, Ltd.

PeraChek, PERACIDIN and PeraSidual are registered trademarks of Alcavis HDC LLC

Plastipak, SafetyGlide and Vacutainer are registered trademarks of Becton Dickinson and Co.

Q.C. Tester is a trademark of U.S. Medical, Inc.

SAF-T-POLE is a trademark of American Medical Manufacturing, Inc.

SPROTTE is a registered trademark of Pajunk GmbH

Statlock is a registered trademark of C.R. Bard, Inc.

Steripick, Locksite, Buttonhole, MasterGuard, Medic, FingerShield, SecureClip
and Streamline are registered trademarks of NxStage Medical, Inc.

SUPOR is a registered trademark of the Pall Corporation

Tevadaptor is a registered trademark of Teva Medical Ltd.

Trissel's is a trademark of Lawrence A. Trissel

Velcro is a registered trademark of Velcro Industries B.V.